

DIVISION No. 10

FISHING

TACKLE

RODS, REELS, LINES, HOOKS, FLIES, LEADERS,
FLY BOOKS, ARTIFICIAL BAITs, SINKERS,
TACKLE BOXES, GAFF HOOKS, SPEARS, MINNOW
BUCKETS, OARS, LANDING AND DIP NETS, MIN-
NOW AND DRAG SEINES, TRAMMEL NETS.

WYETH HARDWARE & MANUFACTURING CO.
SAINT JOSEPH, MO.

FISHING RODS
JAPANESE CANE POLES



Carefully selected stock; our own importation; nicely packed.

			Doz.	100
No. ST10—10-foot; average weight per bundle	45 lbs.	\$0.50	\$ 4.00
No. ST12—12-foot; average weight per bundle	55 lbs.70	5.00
No. ST14—14-foot; average weight per bundle	80 lbs.90	7.00
No. ST16—16-foot; average weight per bundle	58 lbs.	1.20	9.00
No. ST18—18-foot; average weight per bundle	77 lbs.	1.50	13.00
No. ST20—20-foot; average weight per bundle	100 lbs.	1.90	15.00

Packed, 10, 12 and 14-foot, 100 in bundle; others, 50 in bundle.

WOOD BAIT

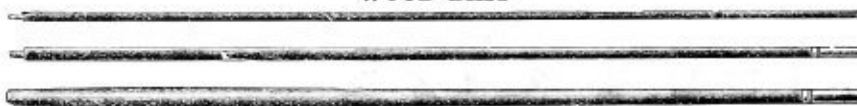

No. ST100—Three-piece; single ferrules; natural color; varnished; length 10 feet; one in paper bag; average weight per dozen	8 lbs.	Doz.	\$ 2.00
--	--------	-------	------	---------

YELLOW JAPANESE BAMBOO



No. ST200—Two-piece; ring guides; double ferrules; length 7 to 9 feet; one in paper bag; average weight per dozen	8 lbs.	Doz.	\$ 3.00
---	--------	-------	------	---------



No. ST204

No. ST201—Three-piece; double ferrules; wire top; length 12 to 14 feet; one in paper bag; average weight per dozen	9 lbs.	Doz.	\$ 4.20
No. ST202—Three-piece; ring guides; double ferrules; length 12 to 14 feet; one in paper bag; average weight per dozen	10 lbs.		6.00
No. ST204—Three-piece; ring guides; brass butt cap and reel bands; length 12 to 14 feet; one in paper bag; average weight per dozen	10 lbs.		8.50



No. ST206—Four-piece; ring guides; double ferrules; brass butt cap and reel bands; length 15 to 17 feet; one in paper bag; average weight per dozen	25 lbs.	Doz.	\$15.50
---	---------	-------	------	---------



No. ST220—Two-piece; scored ebonite grip; nickel plated mountings; shouldered ferrules; standing guides; solid metal reel seat; silk wrapped; length 8 feet; one in paper bag; weight per dozen	6½ lbs.	Doz.	\$11.00
---	---------	-------	------	---------



No. ST222R—Three-piece; scored ebonite grip; nickel plated mountings; shouldered ferrules; covered dowels; standing guides; solid metal reel seat and butt cap; silk wound; length 10 feet; one in paper bag; weight per dozen	7½ lbs.	Doz.	\$13.00
--	---------	-------	------	---------

TRUNK



No. ST250—Four-piece; mottled Japanese trunk rods; length 8 feet; one in partitioned cloth bag; average weight per dozen	6 lbs.	Each	\$ 1.50
--	--------	-------	------	---------

FISHING RODS

HEXAGONAL SPLIT BAMBOO BAIT

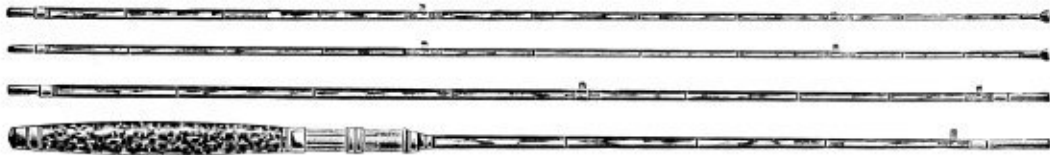

- No. ST520—Three-piece; fair quality hexagonal split bamboo; nickel plated mountings; raised tie guides; solid metal reel seat; cork grip; silk wrapped; length 8½ to 9½ feet; one in plain wood form and cloth bag; average weight per dozen 12 lbs. \$ 1.30
- No. ST522—Three-piece; good quality hexagonal split bamboo; nickel plated mountings; raised tie guides; solid metal reel seat; metal plugs; cork grip; extra tip; silk wrapped; length 8½ to 9½ feet; one in plain wood form and cloth bag; average weight per dozen 12 lbs. 1.70



TRUNK

- No. ST722—Four-piece; split bamboo bait rod; cork grip; nickel plated mountings; metal reel plate; improved ferrules; silk wound; length 7 feet; one in partitioned cloth bag; average weight per dozen 5 lbs \$ 1.70

BAIT CASTING



- No. ST621—Two-piece; cork grip; nickel plated mountings; solid metal reel seat; finger pull; improved welted ferrule; large wire guides and large wire casting tops; wound with silk; one color; length 5 feet; one in partitioned cloth bag; average weight per dozen 5½ lbs. . \$ 1.50

HEDDON



- No. ST501—Two-piece; Heddon original short and long tip design; good quality split bamboo tip; solid wood butt with polished maple handle of special Heddon design; nickel reel seat with hood at rear and trigger on band; all guides of fileproof metal; improved welted ferrules; well wrapped with silk windings in two colors; length 5 feet; one in partitioned cloth bag; average weight per dozen 6 lbs. \$ 1.40



- No. ST502—Two-piece; Heddon original short and long tip design; good quality split bamboo tip with extra tip; solid wood butt with polished maple cord wound handle of special design; nickel reel seat with hood at rear and trigger on band; all guides of fileproof metal; improved welted ferrules; nicely wrapped with silk windings in two colors; length 5 feet; one in partitioned cloth bag; average weight per dozen 6 lbs. \$ 2.70



- No. ST503—Two-piece; Heddon original short butt and long tip design; fine quality split bamboo tip; two tips; split bamboo butt joint and cork grip; extra heavy nickel reel seat with hood and trigger at rear and Heddon locking reel band; first tip has agate tops, other tip and all guides of fileproof metal; improved welted ferrules; well wrapped with silk windings in three colors; length 5 feet; one in partitioned cloth bag; average weight per dozen 6 lbs. \$ 4.00



- No. ST505—Two-piece; Heddon original short butt and long tip design; selected split bamboo tip, with extra tip; selected split bamboo butt joint; solid satin cork of special design with forward grip; extra heavy nickel reel seat with hood at rear and locking reel band; first tip has agate first guide and agate top; other top and other guides of fileproof metal; improved welted ferrules; all metal parts handsomely ornamented; closely wrapped with silk windings in three colors; length 5 feet; one in partitioned cloth bag; average weight per dozen 6 lbs. \$ 7.00

FISHING RODS

SPLIT BAMBOO COMBINATION REVERSIBLE HANDLE



No. ST818

Each

No. ST818—Six-piece; select split bamboo trunk rod; reversible handle; nickel plated mountings; cork grip; can be used either as fly or bait rod with reel seat above or below hand; length 9½ feet; joints 19 inches; tied with green and red silk; silk wound rings and keepers; one in partitioned cloth bag; average weight per dozen 6 lbs.....\$ 4.00

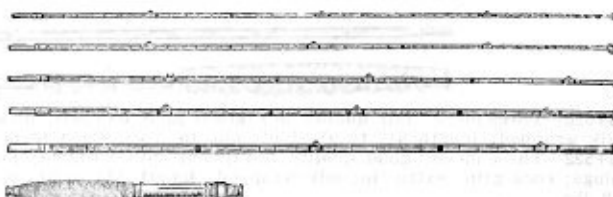

No. ST819

Each

No. ST819—Five-piece; select split bamboo; reversible handle; cork grip; can be used as a fly or bait rod, also equipped with an inserted shortener by means of which a 5½-foot bait casting rod can be made; solid metal reel seat; improved welted ferrules; bronze steel snake guides, silk wound and varnished; length 10 feet; one in canvas partition bag; average weight 12 oz.....\$ 8.50



No. ST815—Consisting of five pieces in all; making a three-piece, 9½-foot fly rod with extra tip or a two-piece, 6-foot bait rod; split bamboo; nickel plated mountings; solid metal reel seat; improved welted ferrules; cork grip; rod wound with green silk and finely varnished; one in velvet covered wood form and cloth bag; average weight per dozen 14 lbs.....\$ 9.00

FLY



No. ST510—Three-piece; good quality hexagonal split bamboo; nickel plated mountings; solid metal reel plate; silk wound snake guides; silk wound at intervals; cork grip, without extra tip; length 9½, 10, 10½ feet; one in cloth partitioned bag; average weight per dozen 7 lbs.\$ 1.30

No. ST512—Three-piece; with extra tip; otherwise same as No. ST510; one in cloth covered wood form and cloth bag; average weight per dozen 11 lbs.....\$ 1.70



No. ST513—Three-piece; split bamboo with extra tip; cork grip; nickel plated mountings; capped ferrules; snake guides; solid metal reel plate; wound at intervals with two colors of silk; finely varnished; length 9½ to 10½ feet; one in cloth covered wood form and cloth bag; average weight per dozen 12 lbs.....\$ 2.00



No. ST613—Three-piece; split bamboo, with extra tip; cork grip; nickel plated mountings; solid metal reel plate; improved and welted ferrules, snake guides; closely wrapped in two colors; nicely varnished; length 9 to 10½ feet; one in cloth covered wood form and cloth bag; average weight per dozen 12 lbs.....\$ 2.70

FISHING RODS

SPLIT BAMBOO FLY



No. ST514—Three-piece; split bamboo, with extra tip; six-strip; cork grip; nickel plated mountings; solid metal reel plate; improved and welted ferrules; metal plugs; silk wound snake guides; fancy spiral silk windings; length 9½ to 10½ feet; one in flannel covered wood form and cloth bag; average weight per dozen 12 lbs. \$ 3.00



No. ST715—Three-piece; split bamboo with extra tip; cork grip; fine nickel plated mountings; solid metal reel seat below the hand; improved welted ferrules; snake guides; silk wound in three colors; length 7½ feet; one in flannel covered wood form and cloth bag; weight per dozen 12 lbs. \$ 4.00

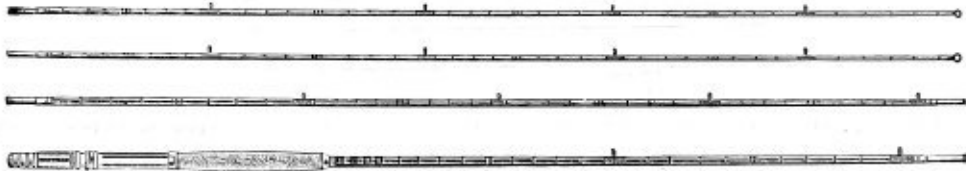

No. ST515—Three-piece; split bamboo, with extra tip; cord wound grip with inlaid cedar extending below the reel seat; nickel plated mountings; solid metal reel seat; improved welted ferrules; snake guides; closely wound in two colors; finely varnished; length 9 to 10½ feet; one in wood form and cloth bag; average weight per dozen 12 lbs. \$ 4.20



No. ST516—Three-piece; split bamboo, with extra tip; cedar inlaid above grip; nickel plated mountings; solid metal reel seat; improved welted ferrules; snake guides; cork grip; wound in three colors; finely varnished; length 9 to 10½ feet; one in flannel covered wood form and cloth bag; average weight per dozen 12 lbs. \$ 4.80



No. ST716—Three-piece; split bamboo; with extra tip; light weight; six strips; solid cork grip; fine nickel plated mountings; solid metal reel seat below the hand; improved and welted ferrules; snake guides; silk wound in two colors; nicely varnished; length 8 feet; one in flannel covered wood form in cloth bag; weight per dozen 10 lbs. \$ 5.00

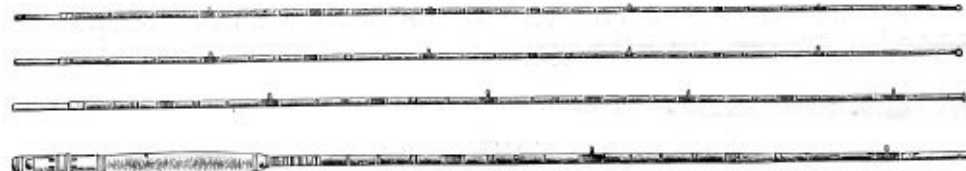

No. ST812—Three piece; split bamboo, with extra tip; six sections V'd and cemented together in a way that makes the rod nearly round; cork grip; fine nickel plated mountings; patent reel seat; welted band; improved ferrules; snake guides; wound with two colors of silk; finely varnished; length 9 to 10 feet; one in flannel covered wood form and cloth bag; average weight per dozen 12 lbs. \$ 7.00

FISHING RODS

SPLIT BAMBOO FLY



- No. ST814C—Three-piece; split bamboo, with extra tip; six-strip; solid cork grip; cedar inlaid; blued mountings; solid metal reel plate; improved and welted ferrules; metal plugs; silk wound snake guides; two colors silk windings; length 9 to 10½ feet; one in velvet covered wood form and cloth bag; average weight per dozen 12 lbs. \$ 7.50
- No. ST816—Three-piece; split bamboo, with extra tip; firmly cemented together and rounded; cork grip; German silver mountings; solid metal reel plate; improved and welted ferrules; snake guides; closely wrapped in two colors; nicely varnished; length 9½ to 10½ feet; one in velvet covered wood form and canvas bag; average weight per dozen 12 lbs. 10.00



- No. ST817—Three-piece; split bamboo with extra tip; six strips firmly cemented together; German silver mountings; solid metal reel plate below the hand; improved and welted ferrules; snake guides; two color silk windings; nicely varnished; length 9½ to 10½ feet; one in velvet covered wood form and canvas bag; weight per dozen 12 lbs. \$17.00



- No. ST712—Trunk; 4-piece; cork grip; nickel plated mountings; metal reel seat below the hand; improved ferrules; silk wound; length 7½ feet; weight 7 oz. \$ 1.70
- Packed, one in cloth partition bag.



- No. ST718—Seven-piece; select split bamboo; pocket fly or bait rod; reversible handle; full nickel mountings; cork grip; bronze snake guides; length 7 feet; length of joints 12½ inches; tied with green and red silk; the handiest rod made; can be carried in the pocket; one in partitioned cloth bag; weight per dozen 5½ lbs. \$ 6.00



- No. ST717—Three-piece, and extra tip; cork grip; full nickel plated mountings; solid metal reel plate below the hand; improved welted ferrules; German silver snake guides; closely wound with garnet silk; finely varnished; length 7½ feet; one in flannel covered wood form and cloth bag; weight per dozen 11 lbs. \$ 7.00

BRISTOL STEEL

The original steel fishing rod; finished in finest black enamel; thoroughly guaranteed.

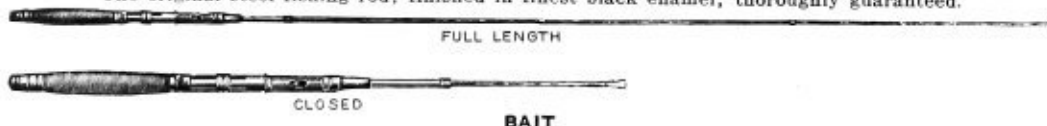

- No. ST3—Bristol bass; telescopic nickel plated handle mountings; each length banded at small end; solid reel seat above the hand; line runs through the center; celluloid wound grip; entire length 10 feet; telescoped 37 inches; one in flannel bag; average weight 10½ oz. \$4.50
- Each \$ 5.68

FISHING RODS

BRISTOL STEEL

The original steel fishing rod; finished in finest black enamel; thoroughly guaranteed.

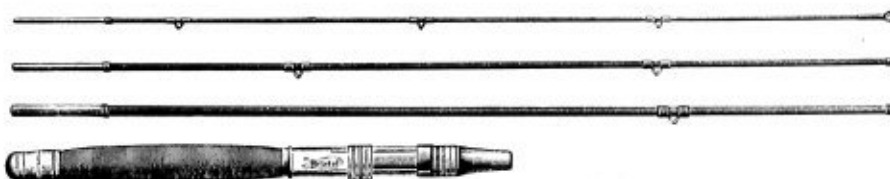

No. ST15—Bristol expert bait or bait casting; nickel plated handle, mountings; solid reel seat above the hand; German silver 2-ring tie guides and 3-ring tip; celluloid wound grip; length 6½ feet; 24-inch joints; one in partitioned flannel bag; average weight 8¼ oz. \$5.00 **Each \$ 6.30**



No. ST11C

No. ST11C—Henshall bass; nickel plated mountings; solid reel seat above the hand; standing guides; 3-ring tip; cork grip; length 8½ feet; 32-inch joints; one in partitioned flannel bag; average weight 10 oz. \$5.50 **Each \$ 6.94**
 No. ST13C—St. Lawrence bass; nickel plated handle, mountings; cork grip; trimmed with 2-ringed German silver tie guides and 3-ringed German silver tip; when telescoped 28 inches long; entire length 7½ feet; one in partitioned flannel bag; average weight 9 oz. \$5.50 **6.94**



TELESCOPIC

No. ST37—Bristol, casting or bait rod; nickel plated handle mountings; cork grip; trimmed with three German silver casting guides; genuine agate casting tip; when telescoped, 23 inches long; has locking joint feature and can be used at any length from 4 to 6 feet; patent detachable finger hook; one in flannel bag; average weight 10 oz. \$6.85 **Each \$ 8.64**

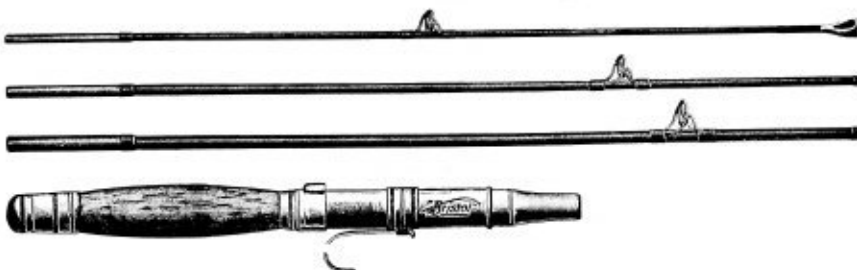

No. ST25—Bristol bait casting; short cork handle; plain detachable finger hook; large polished German silver casting guides; solid agate top with extra large opening; 5 and 5½ feet long; one in partitioned flannel bag; average weight 8 to 10 oz. \$7.00 **Each \$ 8.82**



No. ST28—Bristol bait-casting; light weight; cork grip, metal reel seat above the hand; trimmed with three improved casting guides; special offset agate casting top; 5 and 5½ feet long; one in a partitioned cloth bag; weight 5 oz. \$7.50 **Each \$ 9.46**

FISHING RODS

BRISTOL STEEL

The original steel fishing rod; finished in finest black enamel; thoroughly guaranteed.

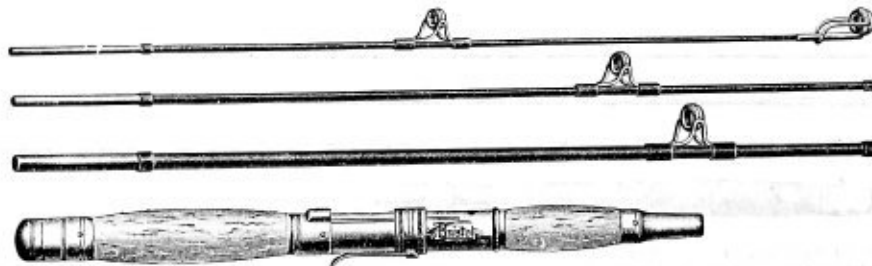

BAIT CASTING

No. ST27—Bait casting; 14-inch handle; cork grips; plain detachable finger hook; German silver mounted, full agate casting guides with large opening; top of special off-set agate style, German silver mounted; length 5 and 5½ feet; one in partitioned flannel bag; average weight 9 to 11 oz. \$11.00 **Each \$13.86**

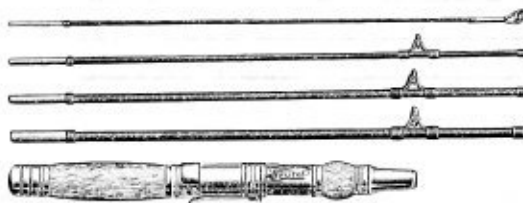

POCKET

No. ST30—Pocket bait casting; improved double cork grip handle, with finger hook; genuine silver mountings; narrow agate first guide; two improved casting guides; angle agate casting tip; length 5 and 5½ feet; one in partitioned cloth bag; average weight 6¾ oz. \$10.00 **Each \$12.60**



TRUNK

No. ST23—Bristol bait; five joints and handle; nickel plated handle mountings; solid reel seat above the hand; German silver two-ring tie guides and three-ring tip; celluloid wound grip; length 7 feet 8 inches; 17¼-inch joints; one in partitioned flannel bag; average weight 9½ oz. \$7.50 **Each \$ 9.46**



FULL LENGTH.



CLOSED.

FLY TELESCOPIC

No. ST6B—Bristol fly; nickel plated handle mountings; solid reel seat below the hand; line runs through center; celluloid wound grip; entire length 10 feet; telescoped 37 inches; one in flannel bag; average weight 10 oz. \$4.00 **Each \$ 5.04**



CLOSED.

FLY TELESCOPIC

No. ST7B—Bristol fly; nickel plated handle mountings; solid reel seat below the hand; line runs through the center; celluloid wound grip; entire length 10 feet; length when telescoped 37 inches; each length is banded at the smaller end; one in cloth bag; average weight 10 oz. \$4.50 **Each \$ 5.68**



FLY CASTING TELESCOPIC

No. ST38—Bristol; nickel plated handle mountings; cork grip; trimmed with two ringed German silver tie guides and German silver one-ring tip; 30 inches long, when telescoped; entire length 9 feet; joints 26½ inches; can be used as bait or fly rod; reversible handle; one in flannel bag; average weight 10 oz. \$5.50 **Each \$ 6.94**



FLY CASTING

No. ST8C—Bristol fly; nickel plated handle mountings; solid reel seat below the hand; German silver 2-ring tie guides and 1-ring fly tip; cork grip; length 10 feet; 38-inch joints; one in partitioned flannel bag; average weight 9½ oz. \$5.50 **Each \$ 6.94**

FISHING RODS

BRISTOL STEEL

The original steel fishing rod; finished in finest black enamel; thoroughly guaranteed.

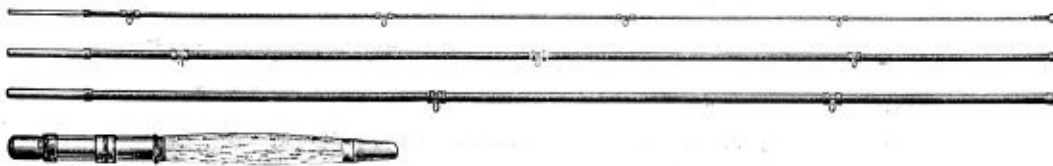

No. ST16C—Bristol Rangely fly; nickel plated handle mountings; solid reel seat below the hand; German silver drop-ring guides and 1-ring fly tip; cork grip; length 9 feet; 34-inch joints; one in partitioned flannel bag; average weight 8¼ oz. \$5.50 **Each \$ 6.94**



No. ST29—Bristol fly; cork grip; metal reel seat below the hand; trimmed with Snake guides and one ring top; 8½ feet long; one in a partitioned cloth bag; weight 5½ oz. \$6.50 **Each \$ 8.20**



No. ST24C—Bristol fly; trunk; six joints and handle; nickel plated handle mountings; solid reel seat below the hand; German silver drop-ring guides and 1-ring fly tip; cork grip; length 9 feet; 17¼-inch joints; one in partitioned flannel bag; average weight 8¼ oz. \$9.00 **Each \$11.34**

RAINBOW STEEL

Thoroughly reliable; moderate priced; finished in dark green enamel; sold without guarantee.

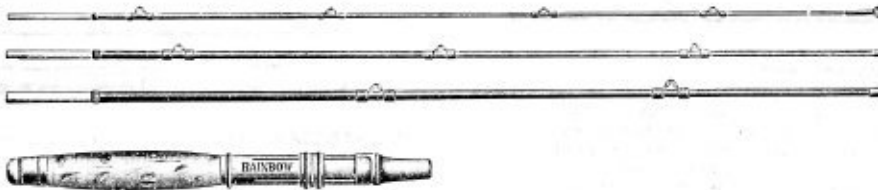

BAIT OR BASS

No. ST211L—Rainbow bass; nickel plated handle mountings; solid reel seat above the hand; German silver 2-ring tie guides and 3-ring tip; cork grip; length 8½ feet; 32-inch joints; complete with locking reel band; one in partitioned flannel bag; average weight 9½ oz. \$2.95 **Each \$ 4.00**



BAIT CASTING

No. ST225L—Rainbow bait casting; nickel plated handle mountings; solid reel seat above the hand; large polished German silver 2-ring casting guides and solid agate tip with large opening; length 5 feet; 18-inch joints; complete with locking reel band; one in partitioned flannel bag; average weight 7½ oz. \$4.15 **Each \$ 5.80**
 No. ST225LA—Rainbow bait casting; nickel plated handle mountings; solid reel seat above the hand; large agate first casting guide and solid agate tip with large opening; length 5 feet; 18-inch joints; complete with locking reel band; one in partitioned flannel bag; average weight 7½ oz. \$4.70 **6.50**

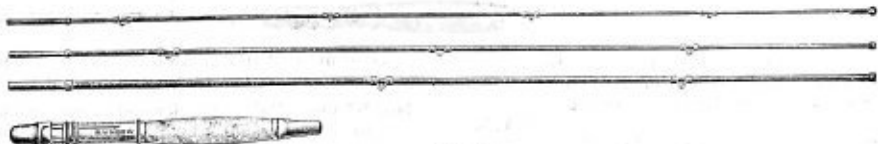

FLY

No. ST208—Rainbow fly; nickel plated mountings; solid reel seat below the hand; standing line guides on outside; cork grip; length 10 feet; one in partitioned flannel bag; average weight 9½ oz. \$2.50 **Each \$ 3.50**

FISHING RODS

SAMSON STEEL

Great care is exercised in the manufacture of Samson steel rods; each rod is thoroughly tested before leaving the factory; not guaranteed. Enameled in dead black.



- No. STB56—Samson bait; cork grip; nickel plated handle mountings; solid reel seat above the hand; locking reel band; snake guides; length 5½ feet; one in partitioned cloth bag; average weight 10 oz. \$ 2.00
- No. STB66—Samson bait; 6½ feet long; otherwise same as No. STB56. 2.00
- No. STB76—Samson bait; 7½ feet long; otherwise same as No. STB56. 2.00
- No. STB86—Samson bait; 8½ feet long; otherwise same as No. STB56. 2.00



- No. STBC5R—Samson bait casting; cork grip; nickel plated handle mountings; solid reel seat above the hand; extra large 2-ring German silver guides and extra large 3-ring casting tip; with casting finger hook on reel band; length 5 feet; one in partitioned cloth bag; average weight 9 oz. . . \$ 2.30
- No. STBC56R—Samson bait casting; 5½ feet long; otherwise same as No. STBC5R 2.30



- No. STBC5—Samson bait casting; cork grip; nickel plated handle mountings; solid reel seat above the hand; extra large 2-ring German silver guides and extra large agate casting tip, with casting finger hook on reel band; length 5 feet; one in partitioned cloth bag; average weight 9 oz. \$ 2.60
- No. STBC56—Samson bait casting; 5½ feet long; otherwise same as No. STBC5 2.60



- No. STBC5A—Samson bait casting; cork grip; nickel plated handle mountings; solid reel seat above the hand; extra large agate first guide; German silver large casting guide; extra large agate casting tip; casting finger hook on reel band; length 5 feet; one in partitioned cloth bag; average weight 9 oz. \$ 3.50
- No. STBC56A—Samson bait casting; 5½ feet long; otherwise same as No. STBC5A 3.50

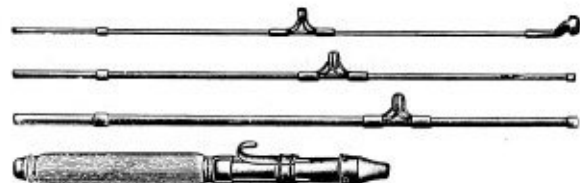

- No. STBC5AA—Samson bait casting; cork grip; nickel plated handle mountings; solid reel seat above the hand; extra large agate casting guides; extra large agate casting tip; casting finger hook on reel band; length 5 feet; one in partitioned cloth bag; average weight 10 oz. \$ 4.50
- No. STBC56AA—Samson bait casting; 5½ feet long; otherwise same as No. STBC5AA 4.50



FLY

- No. STF9—Samson fly; cork grip; nickel plated handle mountings; solid reel seat below the hand; snake guides; 3-ringed top; length 9 feet; one in partitioned cloth bag; average weight 10 oz. \$ 2.00
- No. STF96—Samson fly; 9½ feet long; otherwise same as No. STF9. 2.00
- No. STF10—Samson fly; 10 feet long; otherwise same as No. STF9. 2.00

VALLEY

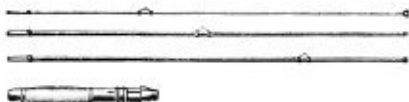

- No. STV5½—Bait; 5½ feet long; cork grip; nickel plated mountings; solid reel seat above the hand; German silver snake guides; three ring top; one in partitioned cloth bag; average weight 6¼ oz. \$ 1.30
 - No. STV6½—Bait; 6½ feet long; otherwise same as No. STV5½. 1.30
 - No. STV7½—Bait; 7½ feet long; otherwise same as No. STV5½. 1.30
 - No. STV8½—Bait; 8½ feet long; otherwise same as No. STV5½. 1.30
- Packed, one in partitioned cloth bag.

VIM

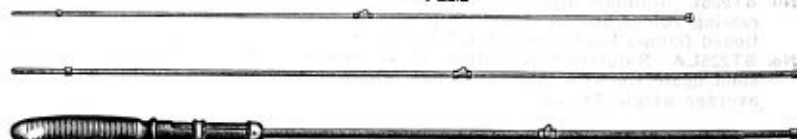

- A good quality rod at a cheap price; each rod is inspected before leaving factory; finished in green enamel.
- No. STV66—Bait; blackwood grip; nickel plated reel mountings; reel seat above the hand; snake guides; length 6½ feet; weight 10 oz. \$ 1.00
 - No. STV76—Bait; 7½ feet long; otherwise same as No. STV66. 1.00
 - No. STV86—Bait; 8½ feet long; otherwise same as No. STV66. 1.00
- Packed, one in partitioned cloth bag.

FISHING REELS

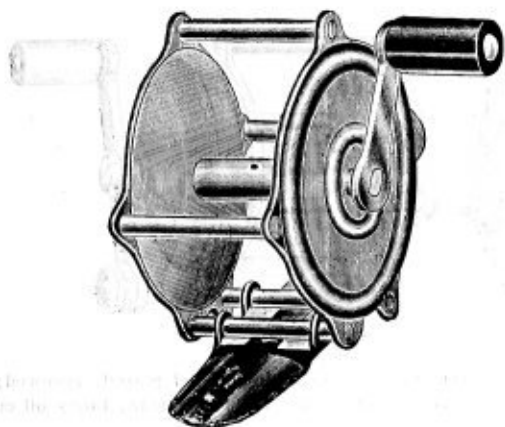

Single action; brass; raised pillar; riveted; 1-inch spool; plain polished.

- No. ST1R—25 yards; diameter 1¾ inches; average weight per dozen 2½ lbs. \$ 1.70
- No. ST2R—40 yards; diameter 2 inches; average weight per dozen 2½ lbs. 1.90
- No. ST3R—60 yards; diameter 2¼ inches; average weight per dozen 2½ lbs. 2.20

Packed, one-half dozen in box.

Single action, with click; brass; raised pillar; riveted; 1-inch spool; plain polished.

- No. ST1½R—25 yards; diameter 1¾ inches; average weight per dozen 2½ lbs. \$ 2.10
- No. ST2½R—40 yards; diameter 2 inches; average weight per dozen 2½ lbs. 2.40
- No. ST3½R—60 yards; diameter 2¼ inches; average weight per dozen 2½ lbs. 2.60

Packed, one-half dozen in box.

Single action, with click; nickel plated; raised pillar; riveted; 1-inch spool.

- No. ST7R—25 yards; diameter 1¾ inches; average weight per dozen 2½ lbs. \$ 2.50
- No. ST8R—40 yards; diameter 2 inches; average weight per dozen 2½ lbs. 2.80
- No. ST9R—60 yards; diameter 2¼ inches; average weight per dozen 2½ lbs. 3.00

Packed, one-half dozen in box.

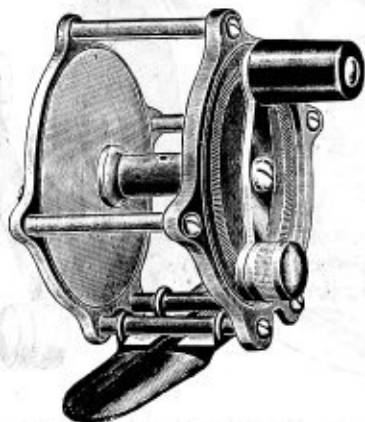

Single action; with back sliding click; nickel plated; raised pillar; screwed; flush balance handle; 1-inch spool.

- No. ST20R—40 yards; diameter 2 inches; average weight per dozen 3 lbs. \$ 7.00
- No. ST21R—60 yards; diameter 2¼ inches; average weight per dozen 3 lbs. 8.00
- No. ST22R—80 yards; diameter 2½ inches; average weight per dozen 3 lbs. 9.00

Packed, one-twelfth dozen in box.



Single action; featherlight; nickel plated; frame and reel seat in one piece; removable spool; back sliding, double pointed steel click and spindle.

- No. ST250R—40 yards; diameter 1¾ inches; average weight per dozen 4 lbs. \$13.32
- No. ST260R—60 yards; diameter 2¼ inches; average weight per dozen 4 lbs. 16.00
- No. ST290R—100 yards; diameter 3 inches; average weight per dozen 4 lbs. 21.34

Packed, one-twelfth dozen in box.

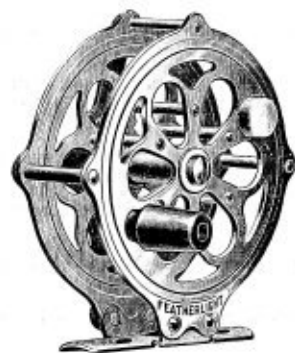

Single action; featherlight; bronze finish; removable spool; back sliding hardened steel click and spindle.

- No. ST370R—70 yards; diameter 2¼ inches; average weight per dozen 3 lbs. \$14.40

Packed, one-twelfth dozen in box.

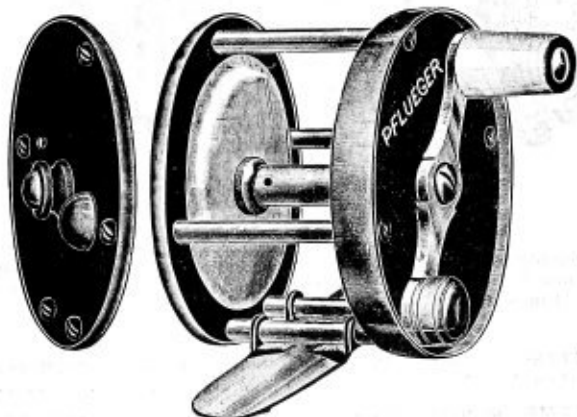

Single action; adjustable back sliding click; hard rubber; metal bound; 1-inch spool.

- No. ST113R—60 yards; diameter 2 inches; weight per dozen 4½ lbs. \$20.00

Packed, one-twelfth dozen in box.

FISHING REELS

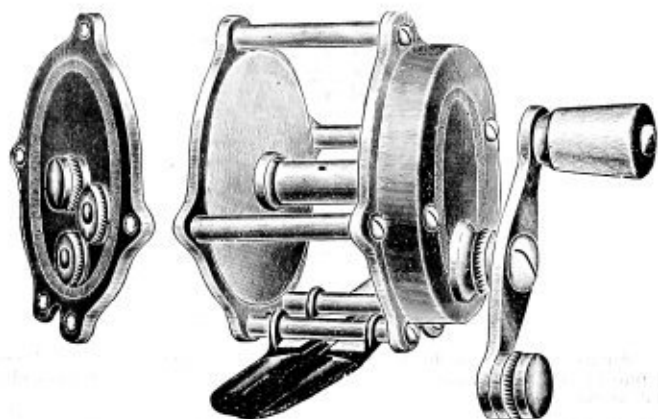

Double multiplying; polished brass; raised pillar; screwed; balance handle; sliding drag and click; 1-inch spool.

- | | |
|---|---------|
| | Doz. |
| No. ST50R—40 yards; diameter 2 inches; average weight per dozen 4¾ lbs. | \$ 7.60 |
| No. ST51R—60 yards; diameter 2¼ inches; average weight per dozen 4¾ lbs. | 8.00 |
| No. ST52R—80 yards; diameter 2½ inches; average weight per dozen 4¾ lbs. | 9.80 |

Packed, one-twelfth dozen in box.

Double multiplying; nickel plated; raised pillar; screwed; balance handle; sliding drag and click; 1-inch spool.

- | | |
|---|---------|
| | Doz. |
| No. ST60R—40 yards; diameter 2 inches; average weight per dozen 4¾ lbs. | \$ 8.40 |
| No. ST61R—60 yards; diameter 2¼ inches; average weight per dozen 4¾ lbs. | 9.00 |
| No. ST62R—80 yards; diameter 2½ inches; average weight per dozen 4¾ lbs. | 10.40 |

Packed, one-twelfth dozen in box.

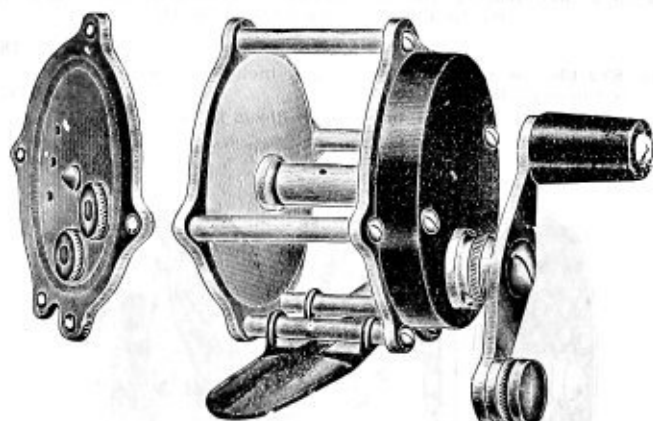

Double multiplying; nickel plated and hard rubber; screwed; balance handle; raised pillar; patent adjustable slide drag; back sliding click; 1-inch spool.

- | | |
|---|---------|
| | Doz. |
| No. ST70R—40 yards; diameter 2 inches; average weight per dozen 4½ lbs. | \$ 9.60 |
| No. ST71R—60 yards; diameter 2¼ inches; average weight per dozen 4½ lbs. | 10.00 |
| No. ST72R—80 yards; diameter 2½ inches; average weight per dozen 4½ lbs. | 11.00 |

Packed, one-twelfth dozen in box.

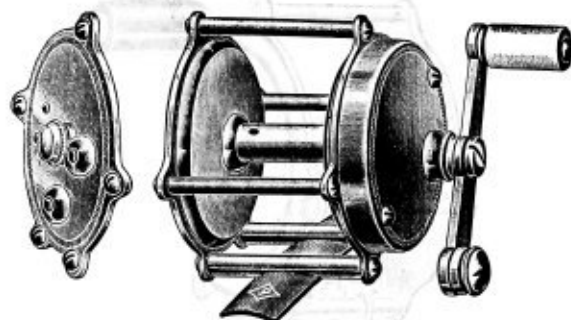

Kentucky pattern double multiplying nickel plated; screwed; balance handle; raised pillar; adjustable click and drag; fancy oil cup on back.

- | | |
|---|---------|
| | Doz. |
| No. ST80R—40 yards; diameter 2 inches; average weight per dozen 4½ lbs. | \$11.00 |
| No. ST81R—60 yards; diameter 2¼ inches; average weight per dozen 4½ lbs. | 12.00 |
| No. ST82R—80 yards; diameter 2½ inches; average weight per dozen 4½ lbs. | 13.00 |

Packed, one-twelfth dozen in box.

Wide pattern; quadruple multiplying; nickel plated; adjustable back sliding click and drag; white handle; bushing and oil cup on back plate; jeweled bearing; 1½-inch spool.

- | | |
|--|---------|
| | Doz. |
| No. ST202R—60 yards; average weight per dozen 5½ lbs. | \$21.00 |
| No. ST203R—80 yards; average weight per dozen 5½ lbs. | 23.00 |

Packed, one-twelfth dozen in box.

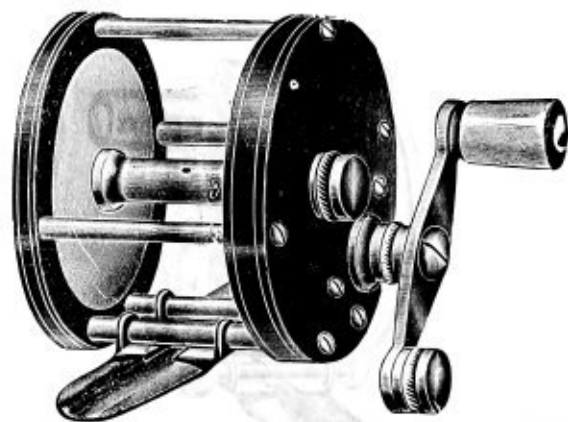

Double multiplying; nickel plated and hard rubber; screwed; patent adjustable slide drag and back sliding click; 1-inch spool.

- | | |
|--|---------|
| | Doz. |
| No. ST101R—60 yards; diameter 2¼ inches; average weight per dozen 5½ lbs. | \$22.00 |
| No. ST102R—80 yards; diameter 2½ inches; average weight per dozen 5½ lbs. | 23.50 |

Packed, one-twelfth dozen in box.

FISHING REELS

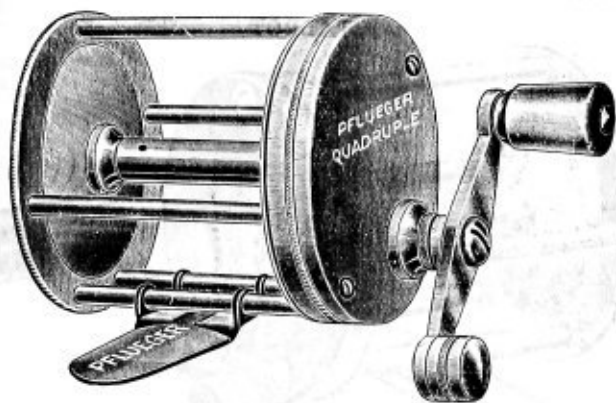

Wide pattern; quadruple multiplying; nickel plated; adjustable back sliding click and drag; white handle; bushing and oil cup back plate; 1 1/4-inch spool.

- | | |
|--|--------------|
| No. ST400R—40 yards; diameter 1 3/4 inches; average weight per dozen 5 1/2 lbs. | Doz. \$15.00 |
| No. ST401R—60 yards; diameter 2 inches; average weight per dozen 5 1/2 lbs. | 16.20 |
| No. ST402R—80 yards; diameter 2 1/4 inches; average weight per dozen 5 1/2 lbs. | 17.40 |

Packed, one-twelfth dozen in box.

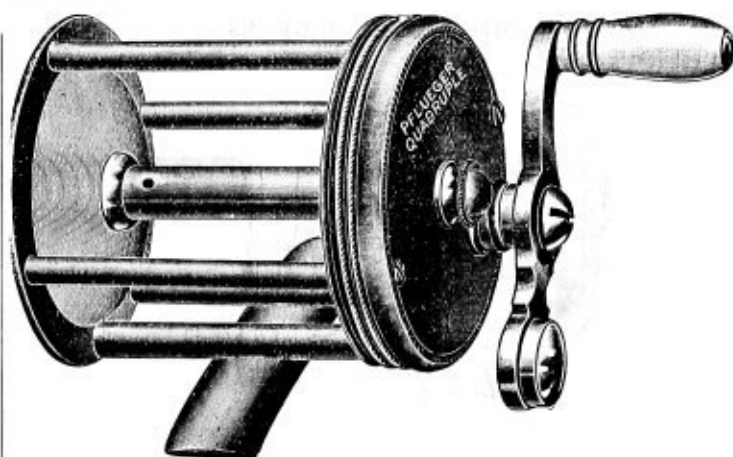

Quadruple multiplying; silverine; screwed; balance handle; patent adjustable slide drag and back sliding click.

- | | |
|--|--------------|
| No. ST223R—60 yards; diameter 2 inches; average weight per dozen 7 lbs. | Doz. \$32.00 |
| No. ST223J—60 yards; jeweled; otherwise same as No. ST223R 42.00 | |
- Packed, one-twelfth dozen in box.

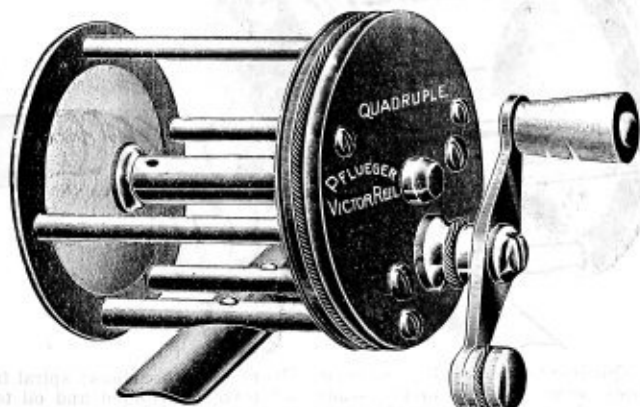

Quadruple multiplying; nickel plated; adjustable back sliding click; steel pivots; pinion; click spring and tongue; white handle; Kentucky pattern cross plate.

- | | |
|---|--------------|
| No. ST502R—60 yards; diameter 2 inches; pillar 1 3/4 inches; average weight per dozen 6 lbs. | Doz. \$18.00 |
| No. ST503R—80 yards; diameter 2 inches; pillar 1 3/4 inches; average weight per dozen 6 lbs. | 19.00 |

Packed, one-twelfth dozen in box.

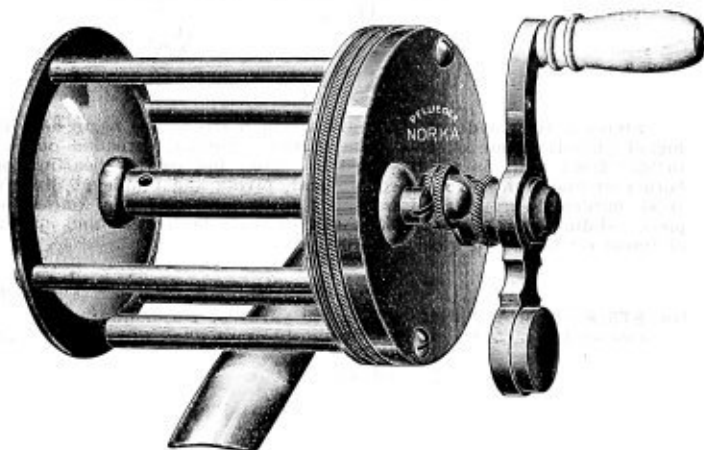

Norka; Kentucky pattern; solid German silver; ivory handle; steel pivots; adjustable click and drag; 1 1/4-inch spool.

- | | |
|--|--------------|
| No. ST793R—60 yards; diameter 2 inches; average weight per dozen 7 1/2 lbs. | Each \$ 7.00 |
| No. ST793J—60 yards; jeweled; otherwise same as No. ST793R | 8.00 |

Packed, one-twelfth dozen in box.

TRI-PART AND TAKAPART

Tubular frame Tri-part and Takapart reels; the term "tubular frame" describes the construction of the frame, and means that the entire frame of the reel is made from a solid piece of tubing, with flat pillars or cross bars; there are no screws or rivets to work loose; highly nickel plated, with head and rear plates; satin finished spool of German silver; patent adjustable slide drag and back sliding click.

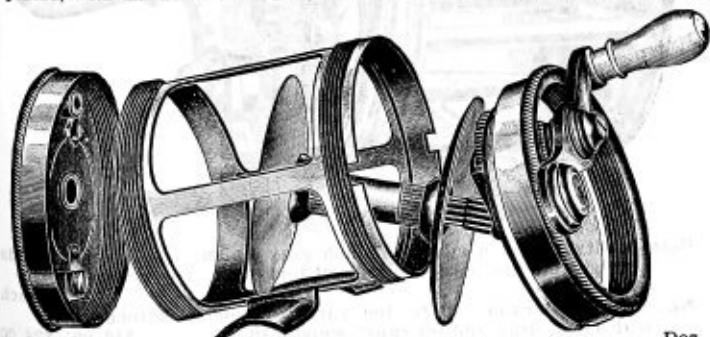

- | | |
|--|--------------|
| No. ST580R—Tri-part; 80 yards; spool 1 3/4 x 1 3/8 inches; average weight 7 oz. | Doz. \$54.00 |
|--|--------------|

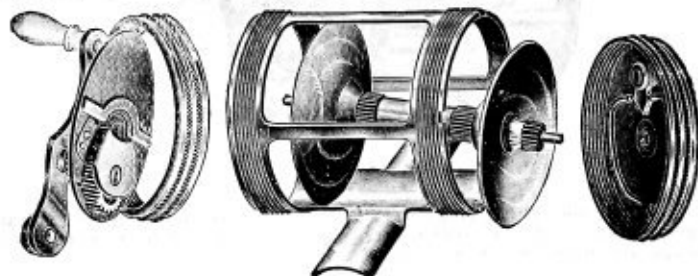

- | | |
|--|--------------|
| No. ST480R—Takapart; 80 yards; spool 1 3/4 x 1 3/8 inches; average weight 7 oz. | Doz. \$66.00 |
|--|--------------|

Packed, one in box.

FISHING REELS

SIMPLEX BLUE GRASS

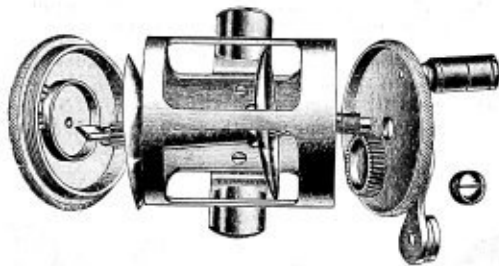
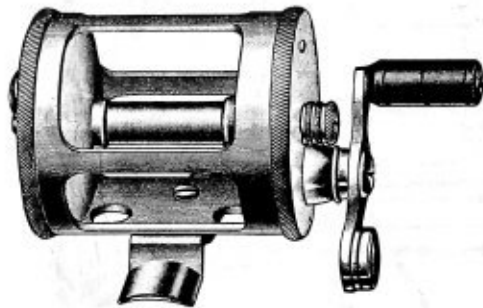

Simplex, reel made of brass and German silver; all parts heavily nickel plated; frame of one piece seamless tubing, threaded on the inside; front plate is rigidly fixed in frame and carries bearing for both rear and front pivot of spool; gear, pivots and pinion of Stubbs steel, hardened, ground and polished; pivots and pinion of one solid piece; sliding click drag on back end of reel; both click and spring of finest oil tempered steel; 1½-inch spool;

Each

No. ST33R—Improved Blue Grass; 120 yards of No. 5 line; diameter 1½ inches; average weight 10 oz.\$11.20

Packed, one in box.

GENUINE BLUE GRASS

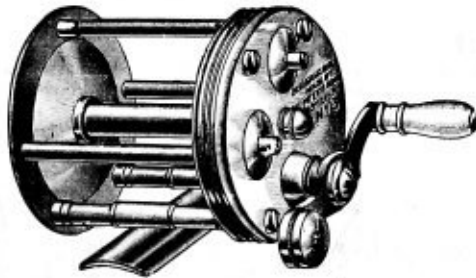

Quadruple multiplying; German silver; Ivory thumb piece; spiral gears; tempered tool steel pivots and stud; screwed balance handle; click and drag; 1½-inch spool.

Each

No. ST3BR—Blue Grass; 120 yards of No. 5 line; diameter 2 inches; weight 10 oz.\$22.50

Packed, one in box.

TALBOT

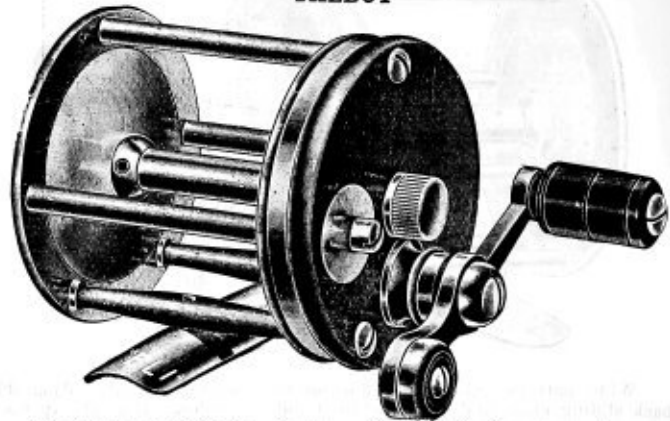

Quadruple multiplying; German silver; plain bearings; improved spiral gears; steel pinions; studs and pivots hardened and oil tempered; aluminum brass wheel; balance handle with rubber grasp; click on front plate; 1½-inch spool.

Each

No. ST34R—Comet; 80 yards; diameter 1¾ inches; average weight 10 oz.\$14.00 \$21.00

Packed, one in box.

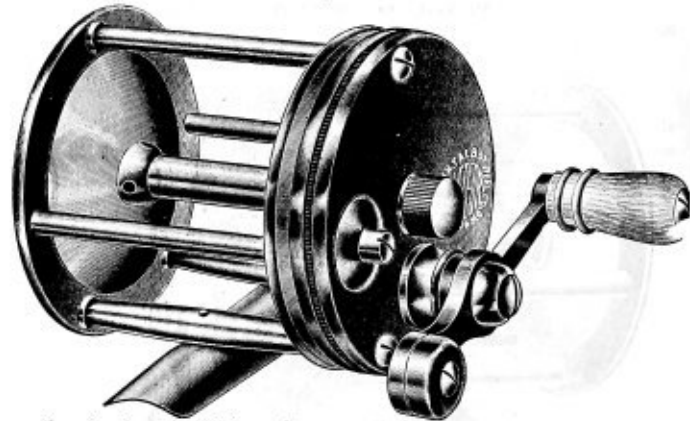

Quadruple multiplying; German silver; plain bearings; spiral frictionless gears; steel pinions; studs and pivots hardened and oil tempered; aluminum bronze wheel; ivory handle; click on front plate; 1½-inch spool.

Each

No. ST35R—Meteor; 100 yards; diameter 2 inches; average weight 10 oz.\$15.00 \$22.50

Packed, one in box.

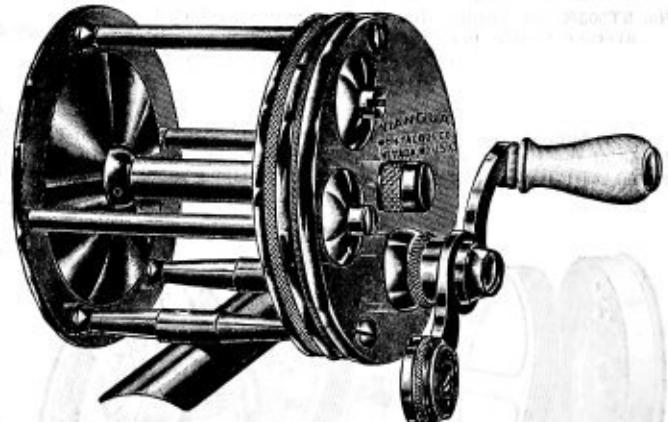

Best quality; German silver; French gray finish; steel pinion; studs and pivots are hardened and oil tempered; 1½-inch spool.

Each

No. ST36R—Niangua; 60 to 100 yards; diameter 2 inches; with click, drag and oil caps; weight 10 oz.\$16.00 \$24.00

No. ST37R—Niangua; with jewels; otherwise same as No. ST36R; weight 10 oz.\$20.00 30.00

Packed, one in box.

FISHING REELS

REDIFORD SELF-THUMBING

Kentucky pattern; quadruple multiplying; nickel; ivory thumb piece; spiral gears; tempered tool steel pivots; screwed; balance handle; with click; 1 3/8-inch spool; inside of the spool of this reel is a device that thumbs the reel mechanically; centrifugally provides a slight pressure proportionate to the speed of the spool, reduced to nothing as the bait slows down and more even than any human thumb can possibly be trained to employ.

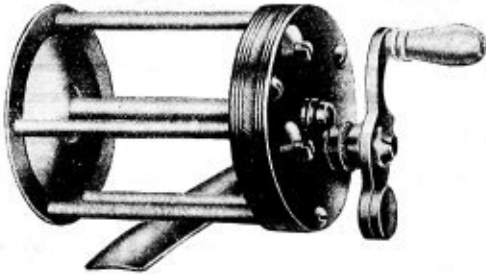

No. ST38R—80 yards; diameter 2 inches; average weight 10 oz. \$100.80
 No. ST39R—With jeweled caps; otherwise same as No. ST38R. 126.00
 Packed, one in box.

ANTI BACK LASH

Quadruple multiplying; solid German silver; white ivoroid thumb piece; balance handle; hunting tooth train gear of hard drawn brass. spool and gear journals are made of a special steel and run in solid phosphor-bronze bushings; adjustable back sliding click; the only reel that works just as if it were thumbed by an expert, the spool being free when the bait is going out and the brake being automatically applied with just the proper force as the line slackens at the end of the cast.

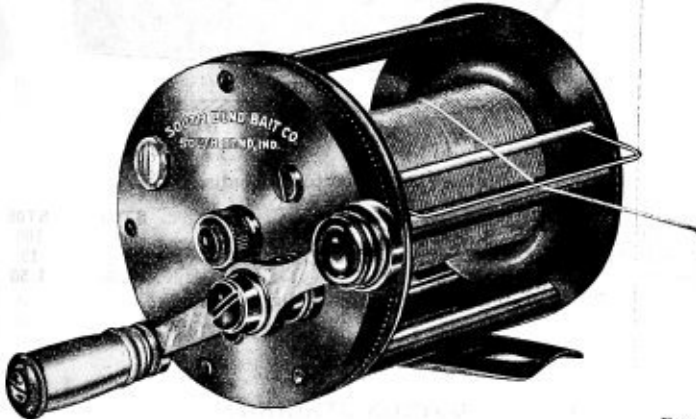

No. ST900R—Capacity 100 yards; weight 10 oz. \$120.00
 Packed, one in box.

MARTIN AUTOMATIC

Endless spring, making it both desirable and durable; has advantage of main spring being readily and easily adjusted to greater or less tension; the Martin reel gives the fish more rope and the angler more sport.



Nickel plated enclosed mechanism.
 No. ST1MR—Creek whipper; holds 75 feet G line; weight 6 oz. \$72.00
 No. ST2MR—Fly casting; holds 90 feet G line; weight 6 oz. 78.00
 No. ST3MR—Extra heavy; holds 150 feet G line; weight 10 oz. 90.00
 Packed, one in box.

YAWMAN AND ERBE AUTOMATIC



Reel operates by pressure of little finger; nickel plated.
 No. ST1A—90 feet; diameter 3 1/2 inches; weight 7 oz. \$60.00 \$80.00
 Packed, one in box.

AUTOMATIC-COMBINATION

Of the two styles of automatic reels, the automatic-combination is a great favorite because it enables the angler to make his cast free running, and the instant slipping of a catch applies the tension, to rewind the line.



Nickel plated with free running feature.
 No. STA—125 feet; diameter 2 7/8 inches; average weight 8 oz. \$84.00 \$112.00
 No. STB—300 feet; diameter 3 3/8 inches; average weight 8 oz. \$96.00 128.00
 Packed, one in box.
 NOTE—No. STA winds automatically, 50 feet of line; No. STB 90 feet of line.

REEL CASES



Tan leather, flannel lined; stitched; strap and buckle fastening; size 2 1/4 x 3 x 3 1/4 inches.
 No. ST69—80 and 100-yard size; weight per dozen 2 1/2 lbs. \$14.00

LINES

TROT

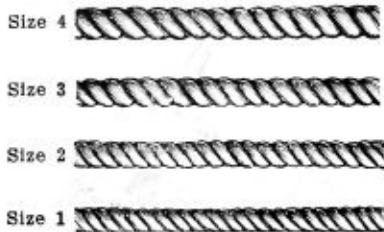

White cotton, in balls.

No. 107—Size	1	2	3	4
Weight per ball, lbs.	1	1¼	1½	1¾
Pound	\$0.50	.50	.50	.50

SEINE TWINE

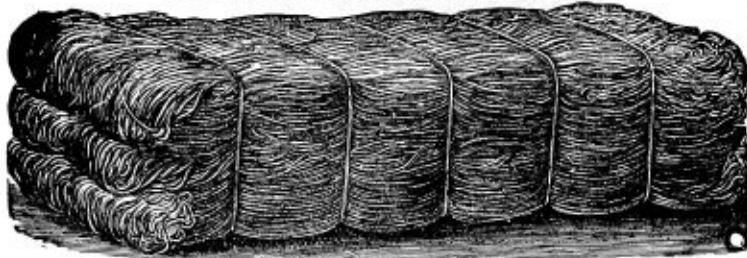

Soft laid best quality, pure white.

No. 108—Size	16	20	24	28	32
Pound	\$0.58	.58	.58	.58	.58

Medium laid, best quality, pure white.

No. 109—Sizes	9	12	15	21	24	27	30	36	42	48
Pound	\$0.62	.60	.59	.59	.59	.59	.59	.59	.59	.58

Packed, five pounds in package.

NOTE—The numbers of seine twine indicate the strands in each size, for example No. 16 has 16 strands, No. 48 has 48 strands, etc.

MASONS'



No. ST5M



Cotton hard laid.

No. ST5M—Yellow; twisted; in 100-foot hanks; weight per dozen 2 lbs.	Doz.	\$ 1.80
No. ST1M—Drab; with one running green thread; braided; in 84-foot hanks; weight per dozen 1¼ lbs.		1.90

Packed, one dozen in box.

CHALK

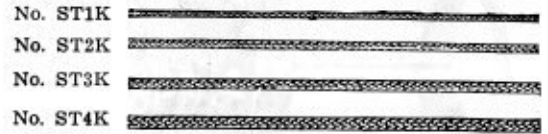
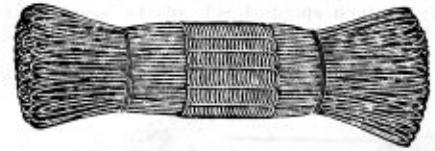

Braided white cotton; in 20-foot hanks.

Nos.	ST1K	ST2K	ST3K	ST4K
Weight per dozen, oz.	3½	5	5½	6
Dozen	\$0.40	.44	.46	.48

Packed, one dozen hanks connected; six dozen hanks in box.

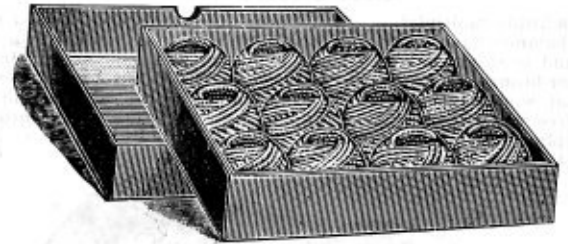

No. ST03

Twisted white cotton in balls.

Nos.	ST03	ST05
Length, feet	50	100
Weight per gross, lbs.	10½	19
Dozen	\$0.84	1.50

Packed, one dozen balls in box.

COTTON STAGING



First quality cotton; in 2-ounce balls.

No. 106—Size, Nos.	12	21	27
Feet in a ball	120	114	75
Pound	\$0.53	.52	.52

Packed, 5 pounds in sack.

FISHING LINES

EUREKA, WHITE COTTON AND LAID LINEN

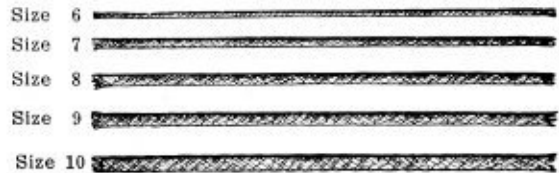

EUREKA; DRAB; TWISTED

15-foot hanks; 12 connected.

No. ST112L—Sizes	1	2	3	4	5	6	7	8	9
Weight per gross, oz.	7	10	12	15	16	18	22	26	32
Dozen	\$0.10	.11	.12½	.15	.16	.18	.20	.23	.25

Packed, six dozen in box.

WHITE COTTON; TWISTED

20-foot hanks; 12 connected.

No. ST113L—Sizes	1	2	3	4	5	6	7	8	9	10	11	12	13	14
Weight per gross, oz.	7	10	14	16	19	20	28	30	35	42	52	58	64	78
Dozen	\$0.09	.11	.12	.14	.15	.16	.18	.20	.23	.25	.30	.34	.38	.42

Packed, twelve dozen in box.

LAID LINEN; TWISTED

20-foot hanks; 12 connected; natural flax color.

No. ST114L—Sizes	1	2	3	4	5	6	7	8	9	10
Weight per gross, oz.	8	9	10	12	14	15	19	26	32	36
Dozen	\$0.18	.20	.23	.25	.30	.34	.38	.42	.46	.55

Packed, six dozen in box.

SEA ISLAND COTTON



Best braided Sea Island cotton.

25-foot hanks, 12 connected.

No. ST110L—Sizes	1	2	3	4	5	6
Weight per gross, lbs.	3¾	3	2¾	2½	1½	1
Dozen	\$0.40	.40	.40	.40	.40	.40

Packed, six dozen in box.

BRAIDED COTTON

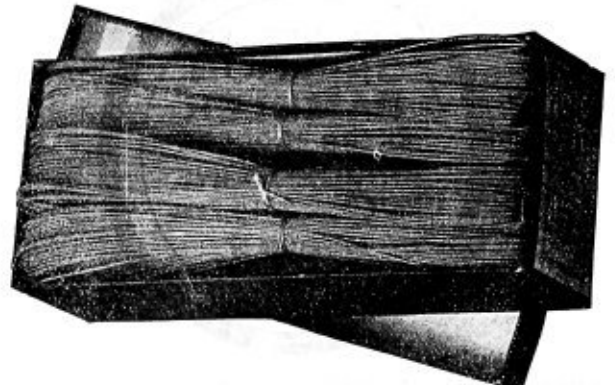

84-foot old style loose hanks, 12 connected.

No. ST111L—Sizes	1	2	3	4	5
Weight per dozen, lbs.	1½	1	¾	¾	¾
Dozen	\$1.40	1.30	1.20	1.20	1.20

Packed, one dozen in box.

FISHING LINES

SUSQUEHANNA BASS



25-foot hanks; 12 connected; electric braided; light green color.

No. ST115L—Sizes	2	3	4	5	6
Weight per gross, oz.	3½	2½	1¾	1½	1
Dozen	\$0.60	.60	.60	.60	.60

Packed, six dozen in box.

ELECTRIC CITY BRAIDED



50 feet on a spool; four connected; black and white check.

No. ST117L—Size	5
Weight per dozen, oz.	19
Dozen	\$1.50

Packed, one dozen in box.

CRIMSON RAMBLER



60 feet on a spool; four connected; made of special quality; enamel finish; braided cotton; green with red check.

No. ST180L—Size	C
Weight per dozen, oz.	22
Dozen	\$2.20

Packed, one dozen in box.

GENUINE IRISH LINEN



50 feet on a card; four connected; natural color.

No. ST116L—Sizes	2	3	4
Dozen	\$1.10	1.15	1.20

Average weight per gross, 3 lbs.

Packed, one dozen in box.

WATERPROOF



Best special braided trout line; genuine sea island cotton; waterproof; 48 threads; 25 yards on card; four connected; dark color mottled with green.

No. ST100L—Trout size; weight per dozen 10 oz.	Doz. \$ 3.50
--	--------------

Packed, one dozen in box.



Best special braided bass line; genuine sea island cotton; waterproof; 48 threads; 25 yards on card; four connected; dark color mottled with green.

No. ST200L—Bass size; weight per dozen 10 oz.	Doz. \$ 3.50
---	--------------

Packed, one dozen in box.

FISHING LINES

EXCELSIOR BRAIDED LINEN

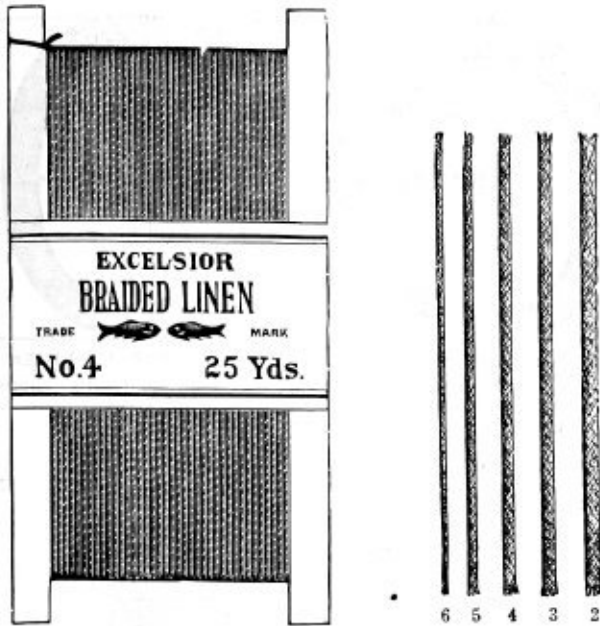

25 yards on a block, four connected; natural color.

No. ST122L—Sizes	6	5	4	3	2
Average weight per 1000 yards, lbs.	2¼	2¼	2¼	2¼	2¼
Thousand yards	\$6.00	6.00	6.00	6.00	6.00

Packed, 500 yards in box.

BEST BRAIDED LISLE THREAD

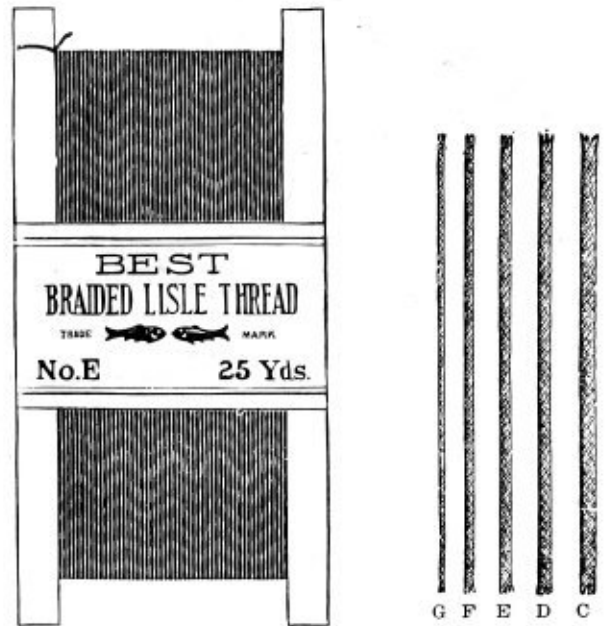

25 yards on a block, four connected; variegated colors.

No. ST120L—Sizes	G	F	E	D	C
Average weight per 1000 yards, lbs.	4	4	4	4	4
Thousand yards	\$5.50	5.50	5.50	5.50	5.50

Packed, 500 yards in box.

HARD BRAIDED LINEN

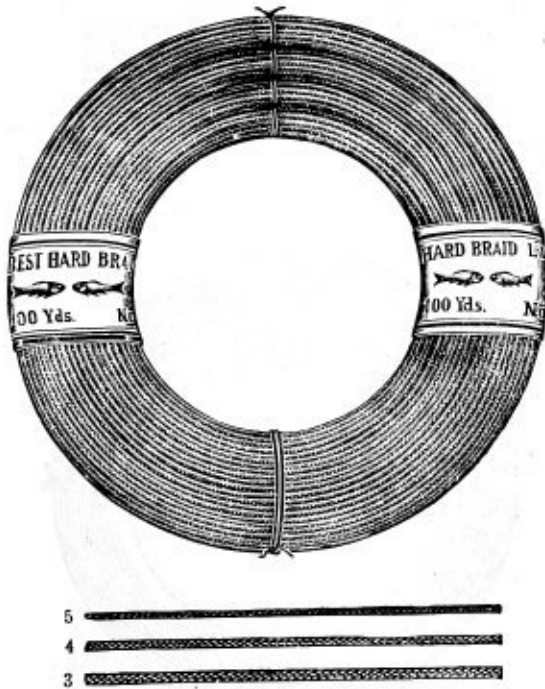

100-yard coils, divided into 25-yard knots; gray color.

No. ST124L—Sizes	5	4	3
Average weight per 1000 yards, lbs.	3	3	3
Thousand yards	\$10.80	10.80	10.80

Packed, 500 yards in box.

WYCO



50 feet on spool; one dozen spools connected; in cardboard box; imitation linen; natural color.

No. ST118L—Size of No. 12 Cuttyhunk; weight per dozen 4 oz.	Doz. \$ 1.80
---	--------------

Packed, one dozen in box.

FISHING LINES

LINEN



STRONG REEL CUTTYHUNK

Put up same as No. ST156L; an extra strong line and one of the best lines on the market for the money.

No. ST157L—Sizes	9	12
Average weight per dozen, oz.	8	8
Dozen	\$1.50	1.60

Packed, one dozen in box.



GENUINE CUTTYHUNK TWISTED LINEN

50 yards on a spool; two connected; made of highest quality imported genuine Irish linen; natural gray.

No. ST123L—Sizes	9	12	15	18	21
Average weight per dozen, lbs.	1 7/8	1 3/4	1 3/8	1 1/4	1 1/8
Dozen	\$6.00	6.50	7.00	7.50	8.50

Packed, one-half dozen in box.

OILED SILK



Wyco special oil silk; waterproof finish; 10 yards on card.

No. ST95L—Size	5
Average weight per dozen, lbs.	5 1/2
Dozen	\$1.80

Packed, one dozen in box.



WATERPROOF GENUINE CUTTYHUNK TWISTED LINEN

50 feet on card; six connected; made of highest quality improved genuine Irish linen; natural gray.

No. ST156L—Sizes	9	12
Test pounds	18	24
Average weight per dozen, oz.	7	7
Dozen	\$2.50	2.70

Packed, one dozen in box.

OILED SILK

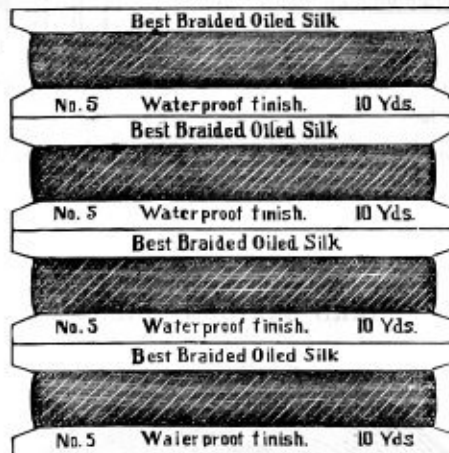

10 yards on a cardboard winder; 12 connected as shown in cut.

No. ST133L—Sizes	5	4
Average weight per dozen, oz.	4	4
Dozen	\$1.40	1.80

Packed, one-half gross in box.



Warranted all silk; each line sewed on card as shown in cut; 25 yards on card; four connected.

No. ST126L—Sizes	5	4	3
Average weight per dozen, lbs.	5 1/2	5 1/4	5 1/8
Dozen	\$5.60	6.40	8.00

Packed, one dozen in box.

FISHING LINES

PURE BRAIDED SILK

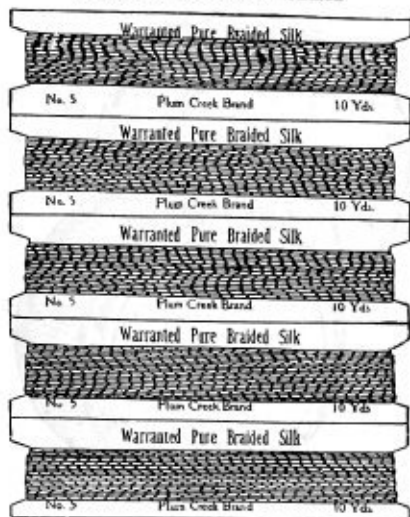

10 yards on cardboard winder; 12 connected.

No. ST190L—Sizes	5	4	3
Average weight per box of 720 yards, lbs.	1 3/4	1 3/4	1 3/4
Thousand yards	\$15.00	16.80	24.00

Packed, 720 yards in box.

BEST BRAIDED RAW SILK



25 yards on block; four connected; colors green and white, or black and white, mottled.

No. ST130L—Sizes	6	5	4	3	2
Average weight per 1000 yards, lbs.	1 1/2	1 1/2	1 1/2	1 1/2	1 1/2
Thousand yards	\$16.00	16.00	22.00	26.00	32.00

Packed, 500 yards in box.

OTSELIC BRAIDED SILK

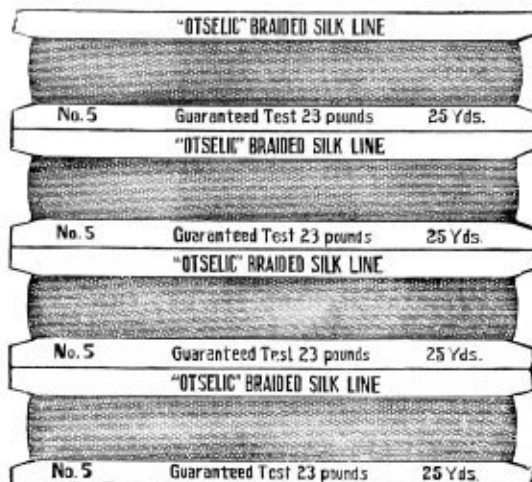

25 yards on a card; four connected.

Nos.	ST141 1/2 L	ST143 L	ST145 L	ST146 L
Test pounds	12	17	23	30
Average wt. per 1000 yds., lbs.	1 3/4	1 3/4	1 3/4	1 3/4
Thousand yards	\$19.00	24.00	31.60	38.00

Packed, 500 yards in box.

PEERLESS HARD BRAIDED SILK

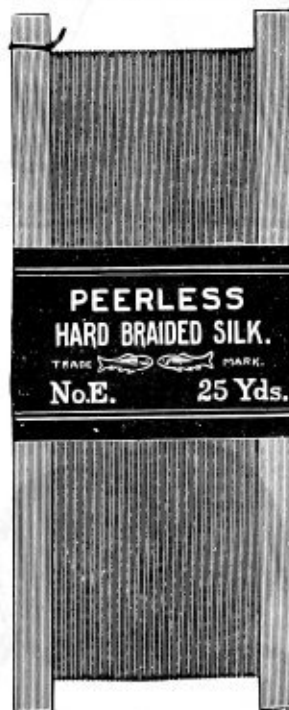

Braided over a core; making a perfectly round line that will not flatten; 25 yards on block; four connected; colors bronze, bronze and orange, bronze and green mottled.

No. ST131L—Sizes	E	F	G	H
Average weight per 1000 yards, lbs.	1 1/2	1 1/2	1 1/2	1 1/2
Thousand yards	\$36.00	30.00	24.00	20.00

Packed, 500 yards in box.

FISHING LINES

CASTING



CHALLENGE HARD BRAIDED SILK

High grade silk casting line; black and white mottled; 50 yards on a spool; two connected.

	Thousand Yards	
No. ST530L—Test 20 lbs.....		\$18.50
No. ST540L—Test 15 lbs.....		16.00
No. ST550L—Test 12 lbs.....		15.00

Packed, 100 yards in box.



GOLD SEAL

50 yards on a spool; two connected; made in black of highest grade waterproof Japan silk; no dye used.

Nos.....	ST129L	ST139L
Test pounds.....	12	17
Weight per 1000 yards, lbs.....	1 1/4	1 1/4
Thousand yards.....	\$24.00	30.00

Packed, 100 yards in box.



MARTIN KINGFISHER

Martin's highest grade braided silk casting line; 50 yards on a spool; two connected; black and white check.

No. ST160L—Sizes.....	2	3	4	5
Test pounds.....	28	23	16	12
Average weight per 1000 yards, lbs.....	1	1	1	1
Thousand yards.....	\$38.86	32.06	25.24	21.32

Packed, 100 yards in box.



MARTIN LITTLE JAP

Made of choicest Japanese silk; oriental design; 25 yards on a spool; four connected; mixture of white and black.

Nos.....	ST165L	ST166L
Test pounds.....	12	16
Average weight per 1000 yards, lbs.....	1	1
Thousand yards.....	\$14.96	17.16

Packed, 100 yards in box.



KINGFISHER GREEN AND BRONZE KING

50 yards on a spool; two connected; finest silk closely braided and very smooth running, in size B, tested at 16 pounds.

Nos.....	ST163L	ST164L
Color.....	green	bronze
Average weight per 1000 yards, lbs.....	1	1
Thousand yards.....	\$19.84	19.84

Packed, 100 yards in box.

FISHING LINES

KINGFISHER SPIRAL BRAID



CASTING

50 yards on a spool; two spools connected; made of finest silk procurable; braided by a new method, this line appears as though it were twisted, therefore the name spiral braid.

Nos.	ST161L	ST162L
Sizes	40	30
Test pounds	22	28
Weight per 100 yards, lbs.	2	2
Thousand yards	\$39.00	49.40

Packed, 100 yards in box.

SILVER JOE



Enameled waterproof silk; 25 yards on a card; four cards connected; one of the most popular lines of the season.

No.	ST168L
Weight per 1000 yards, lbs.	1 1/2
Thousand yards	\$20.80

Packed, 100 yards in box.

KINGFISHER TROUT



25 yards on a card; four connected; ideal for trout fishing; very small in diameter; waterproof; test 10 lbs.

No. ST167L—Russet finish; weight per 1000 yards 1 1/2 lbs.	Thousand Yards	\$25.92
Packed, 100 yards in box.		

KINGFISHER ENAMELED SILK

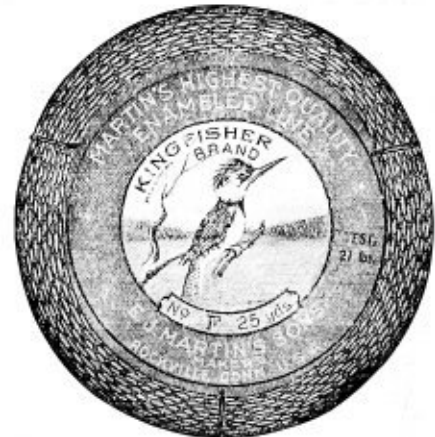

Martin's highest quality braided, enameled silk; waterproof; 25 yards on a card; four cards connected; black and green color.

No. ST170L—Sizes	7	H	G	F	E
Test pounds	10	14	16	22	28
Average weight per 1000 yards, lbs.	2	2	2	2	2
Thousand yards	\$42.22	46.66	50.56	53.36	60.02

Packed, 100 yards in box.

SALINE



Braided enameled silk; 25 yards on card; four cards connected; waterproof.

No. ST127L—Sizes	H	G	F	E
Weight per 1000 yards, lbs.	2	2	2	2
Thousand yards	\$33.00	36.00	42.00	48.00

Packed, 100 yards in box.

FISHING LINES

FURNISHED

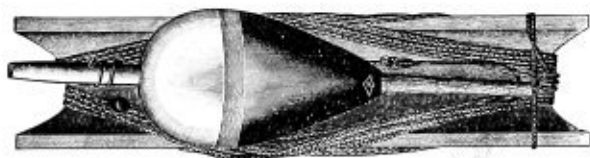

No. ST5FL—Length 12 feet; drab cable laid line on hollow stained wood winder; complete with 1½-inch egg shape adjustable stick top float; three colors; ringed hook and sinker; weight per dozen ¾ lb.\$ 0.40
Packed, three dozen in cardboard box.



No. ST10FL—Length 12 feet; drab cable laid line on hollow stained wood winder; complete with 1¾-inch egg shape adjustable wood float; two colors, ringed hook and sinker; weight per dozen ¾ lb.\$ 0.60
Packed, three dozen in cardboard box.

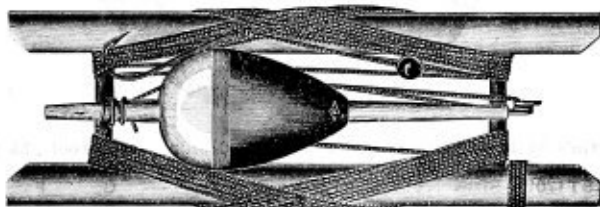

No. ST15FL—Length 12 feet; medium heavy drab cable laid line on black enameled reel; complete with 1½-inch egg shape adjustable stick top wood float; three colors; ringed hook and sinker; weight per dozen ¾ lb.\$ 0.80
Packed, two dozen in cardboard box.

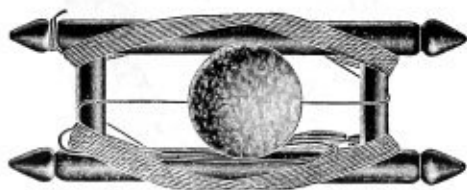

No. ST40FL—Length 15 feet; green cable laid line on black enameled reel; complete with 1-inch ball shaped cork float, natural color; ringed hook and shot sinker; weight per dozen ¾ lb.\$ 0.80
Packed, one dozen in cardboard box.

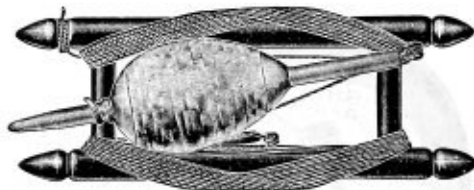

No. ST20FL—Length 15 feet; medium olive green Sea Island cotton line on black enameled reel; complete with 1¼-inch egg shape cork; adjustable stick top float; natural finish; ringed hook and adjustable sinker; weight per dozen ¾ lb.\$ 1.00
Packed, one dozen in cardboard box.

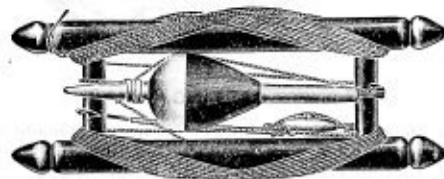

No. ST50FL—Length 15 feet; green cable line, on white enameled reel, complete with 2¼-inch fancy striped, barrel shape adjustable cork float; snelled hook and adjustable sinker; weight per dozen ¾ lb.\$ 1.80

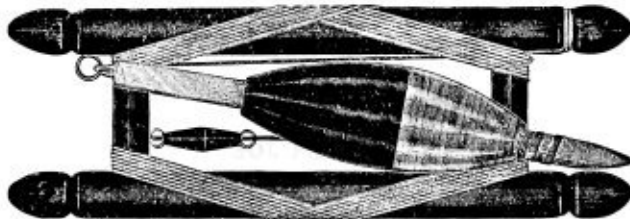

No. ST148FL—Length 15 feet; braided near-silk line on enameled reel; complete with 2½-inch barrel shape adjustable stick top wood float; three colors; single gut Carlisle snelled hook and clincher sinker; weight per dozen ¾ lb.\$ 1.20
Packed, one dozen in cardboard box.

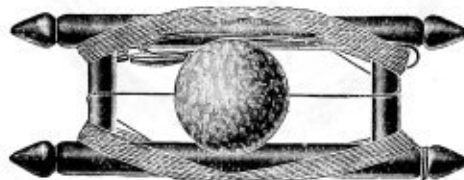

No. ST45FL—Length 15 feet; braided cotton line on black enameled acorn reel; complete with 1¼-inch polished ball shape cork float; natural color; single gut Carlisle snelled hook and adjustable ringed sinker; weight per dozen ¾ lb.\$ 1.30
Packed, one dozen in cardboard box.

FURNISHED FISHING LINES

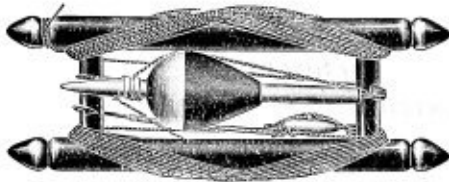

No. ST30FL—Length 15 feet; mottled braided line, on enameled reel, complete with 1 3/4-inch egg shape cork adjustable stick top float; Carlisle ringed hook and adjustable sinker; weight per dozen 3/4 lb. \$ 1.70

Packed, one dozen in cardboard box.

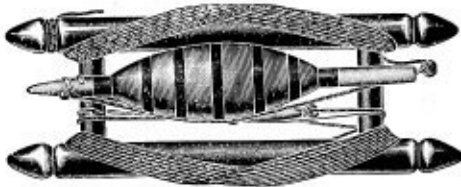

No. ST35FL—Length 15 feet; braided silk line on enameled reel, complete with 1 3/4-inch egg shape cork adjustable quill top float; single gut Carlisle snelled hook and clincher sinkers; weight per dozen 3/4 lb. \$ 2.40

No. ST36FL—With 2 1/2-inch barrel shape cork and adjustable quill top float; otherwise same as No. ST35FL. 2.40

Packed, one dozen in cardboard box.

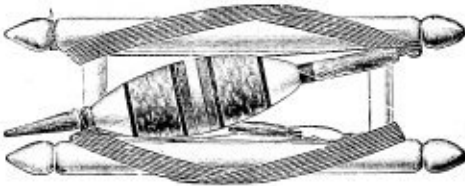

No. ST25FL—Length 15 feet; braided near-silk line on enameled reel; complete with 1 3/4-inch egg shape adjustable stick top wood float, three colors; single gut Carlisle snelled hook and clincher sinker; weight per dozen 3/4 lb. \$ 1.20

Packed, one dozen in cardboard box.

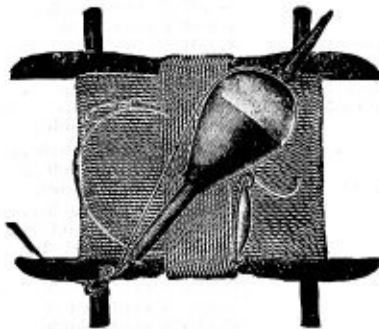

DIPSEA

No. ST80FL—Length 30 feet; medium heavy olive green polished Eureka line on enameled reel; complete with 1 3/4-inch egg shape adjustable stick top float; three colors; single gut snelled hook and adjustable ringed sinker; weight per dozen 1 lb. \$ 1.00

Packed, one dozen in cardboard box.

TROT LINES

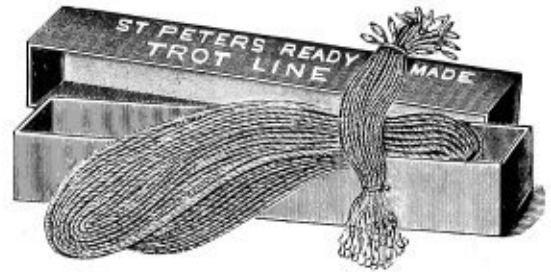

ST. PETER READY MADE

The hook lines are readily attached to the trot lines by looping them on. If the hook lines are placed 3 feet apart they will just take up the 50 yards of trot line, and the hook lines being 12 inches long will give plenty of play between each hook.

Each

No. ST84—50 yards, size 3 trot line; complete with 50 double 12-inch hook lines made of size 21 seine twine and rigged with 4/0 Kirby hooks; weight 1 lb. \$ 0.60

Packed, one in box.

FISHING TACKLE ASSORTMENTS

RANGELY



CONTENTS OF ASSORTMENT

100 Kirby ringed hooks, No. 1	Retail 2 for 1 cent	\$ 0.50
100 Limerick ringed hooks, No. 2	Retail 2 for 1 cent	.50
100 Kirby ringed hooks, No. 3	Retail 2 for 1 cent	.50
100 Limerick ringed hooks, No. 1	Retail 2 for 1 cent	.50
100 Kirby ringed hooks, No. 2	Retail 2 for 1 cent	.50
12 Furnished fish lines, with floats	Retail 5 cents each	.60
24 Ringed sinkers, assorted	Retail 1 cent each	.24
24 Furnished fish lines	Retail 1 cent each	.24
24 Eureka hank lines	Retail 1 cent each	.24
12 Eureka hank lines	Retail 3 cents each	.36
12 Adjustable floats, assorted	Retail 5 cents each	.60

Total retail value \$ 4.78

No. ST30A—In a neat box, size 11 1/2 x 14 1/2 inches; weight 2 1/2 lbs. \$ 2.70

FISHING TACKLE ASSORTMENTS



STANDARD
CONTENTS OF ASSORTMENT

500 Kirby hooks; assorted sizes.....	Retail 2 for 1 cent.....	\$ 2.50
300 Carlisle hooks; assorted sizes.....	Retail 1 cent each.....	3.00
200 Cincinnati bass hooks; assorted sizes.....	Retail 1 cent each.....	2.00
36 snelled hooks; assorted sizes.....	Retail 2 cents each.....	.72
12 adjustable floats; assorted sizes.....	Retail 5 cents each.....	.60
12 ecru Eureka lines; 15-foot; small size.....	Retail 1 cent each.....	.12
12 ecru Eureka lines; 15-foot; medium size.....	Retail 2 cents each.....	.24
12 green Eureka lines; 20-foot; large size.....	Retail 3 cents each.....	.36
24 ringed sinkers; assorted sizes.....	Retail 1 cent each.....	.24
12 extra service lines; 10 yards each.....	Retail 5 cents each.....	.60
18 furnished lines on fancy winder.....	Retail 1 cent each.....	.18
6 furnished lined on japanned bamboo reels.....	Retail 5 cents each.....	.30
6 furnished lines on japanned bamboo reels.....	Retail 10 cents each.....	.60
2 boxes split shot.....	Retail 5 cents each.....	.10
Total retail value.....		\$11.56
		Asst.
No. ST20A—Standard; in neat box; size 18½x13 inches; weight 4 lbs.....		\$ 5.50



AMERICAN
CONTENTS OF ASSORTMENT

700 Kirby hooks; assorted sizes.....	Retail 2 for 1 cent.....	\$ 3.50
100 Kirby hooks; size 3/0.....	Retail 1 cent each.....	1.00
100 Carlisle hooks; size 1/0.....	Retail 1 cent each.....	1.00
100 Carlisle hooks; size 3/0.....	Retail 2 cents each.....	2.00
36 snelled hooks; assorted sizes.....	Retail 2 cents each.....	.72
6 trolling spoon baits.....	Retail 10 cents each.....	.60
54 adjustable sinkers.....	Retail 1 cent each.....	.54
8 adjustable floats.....	Retail 5 cents each.....	.40
6 adjustable floats.....	Retail 10 cents each.....	.60
12 braided lines.....	Retail 5 cents each.....	.60
72 Eureka lines.....	Retail 1 cent each.....	.72
24 Eureka lines.....	Retail 2 cents each.....	.48
30 furnished lines.....	Retail 2 cents each.....	.60
10 furnished lines.....	Retail 3 cents each.....	.30
6 furnished lines.....	Retail 5 cents each.....	.30
6 furnished lines.....	Retail 10 cents each.....	.60
12 best trout lines, on cards.....	Retail 5 cents each.....	.60
Total retail value.....		\$14.56
		Asst.
No. ST10A—American; in fancy box; size 18x17 inches; weight 6 lbs.....		\$ 9.00



MONARCH
CONTENTS OF ASSORTMENT.

600 Kirby hooks, Nos. 1 to 6.....	Retail 2 for 1 cent.....	\$ 3.00
100 Kirby hooks, No. 3/0.....	Retail 1 cent each.....	1.00
200 Carlisle hooks, Nos. 1 and 4.....	Retail 1 cent each.....	2.00
100 Carlisle hooks, No. 4/0.....	Retail 2 cents each.....	2.00
300 Cincinnati bass, Nos. 22-23-24.....	Retail 1 cent each.....	3.00
12 patent adjustable ringed sinkers No. 1.....	Retail 1 cent each.....	.12
12 patent adjustable ringed sinkers No. 2.....	Retail 1 cent each.....	.12
12 patent adjustable ringed sinkers No. 3.....	Retail 1 cent each.....	.12
12 patent adjustable ringed sinkers No. 4.....	Retail 1 cent each.....	.12
10 furnished lines.....	Retail 5 cents each.....	.50
10 furnished lines.....	Retail 10 cents each.....	1.00
6 silkline lines on card.....	Retail 5 cents each.....	.30
12 best quality braided silk line on card.....	Retail 10 cents each.....	1.20
24 Eureka lines.....	Retail 2 cents each.....	.48
12 braided lines.....	Retail 5 cents each.....	.60
3 nickel reels.....	Retail 25 cents each.....	.75
3 nickel multiplying reels.....	Retail 50 cents each.....	1.50
6 boxes split BB shot.....	Retail 5 cents each.....	.30
4 boxes split buck shot.....	Retail 5 cents each.....	.20
12 adjustable floats.....	Retail 5 cents each.....	.60
6 adjustable floats.....	Retail 10 cents each.....	.60
36 snelled hooks.....	Retail 2 cents each.....	.72
6 spoon bait.....	Retail 10 cents each.....	.60
6 Redfield hollow cork patent floats.....	Retail 15 cents each.....	.90
Total retail value.....		\$21.73
		Asst.
No. ST1A—Monarch; in a neat box, size 18¼x18¼x8½ inches; weight 8 lbs.....		\$17.00

FISHING HOOKS

RINGED

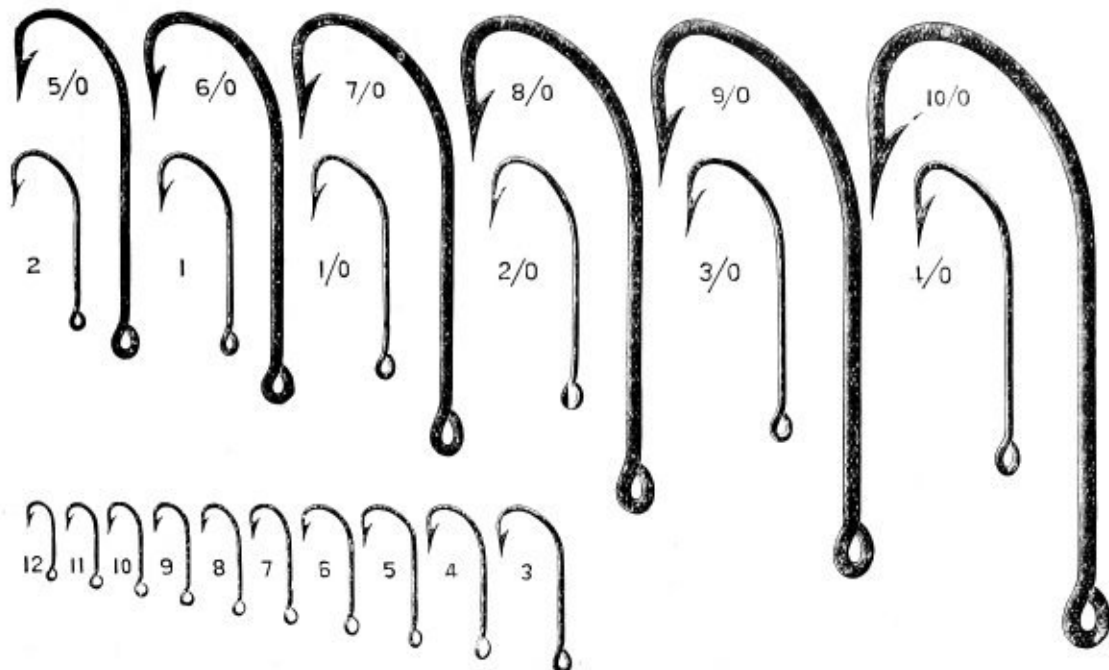

LIMERICK

Extra quality American.

No. ST1—Sizes	10/0	9/0	8/0	7/0	6/0	5/0	4/0	3/0	2/0	1/0	1 to 12
Weight per 1000, lbs.	14	10	7	5	4	2½	1½	1½	1¼	¾	½
Thousand	\$6.00	4.70	3.30	2.40	2.10	1.70	1.50	1.20	1.10	1.00	.80

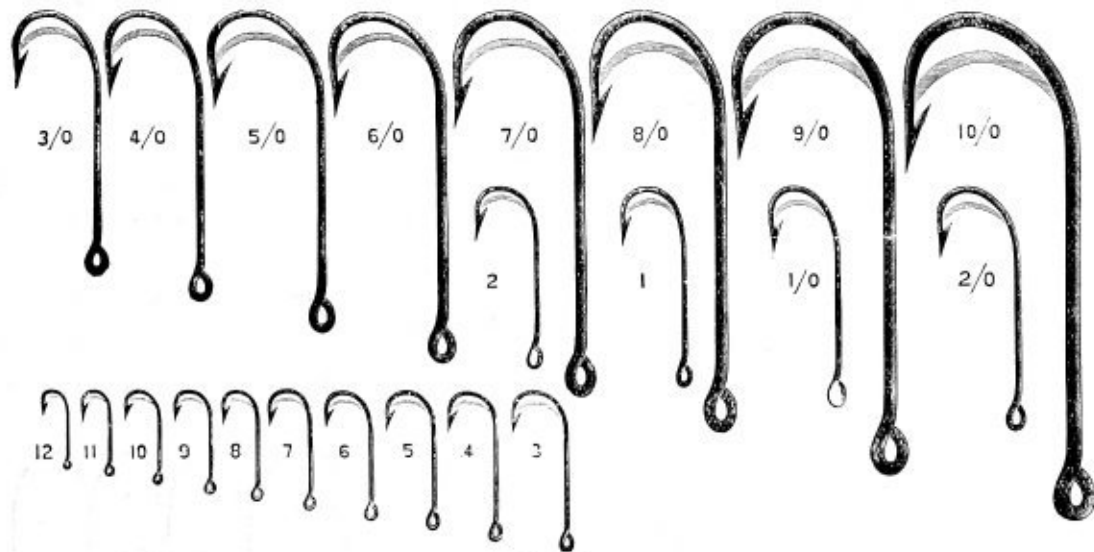

KIRBY

Extra quality American.

No. ST2KH—Size	10/0	9/0	8/0	7/0	6/0	5/0	4/0	3/0	2/0	1/0	1 to 12
Weight per 1000, lbs.	14	10	7	5	4	2½	2	1½	1½	1	¾
Thousand	\$6.00	4.70	3.30	2.40	2.10	1.70	1.50	1.20	1.10	1.00	.80

Best quality English; spear point.

No. ST3KH—Sizes	6/0	5/0	4/0	3/0	2/0	1/0	1 to 8
Weight per 1000, lbs.	4	2½	2	1½	1½	1	¾
Thousand	\$3.00	2.50	2.20	2.00	1.80	1.60	1.20

SEA HOOKS

Best quality English; bent sea; hollow point.

No. ST25H—Sizes	6	7	8	9	10	11	12
Weight per 1000, lbs.	5¾	4	2¾	2	1¼	1	¾
Thousand	\$10.50	8.30	6.20	5.20	4.20	3.80	3.20

Packed, 100 in box; 1,000 in carton.

FISHING HOOKS

RINGED

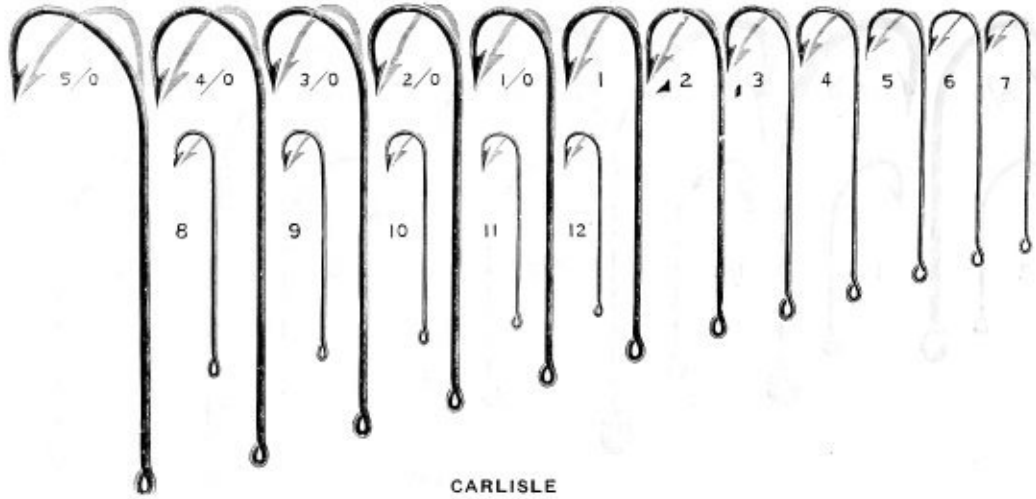

CARLISLE

Fine quality American; blued.

Best quality English; spear point.

No. ST4C—Sizes	6/0	5/0	4/0	3/0	2/0	1/0	1 to 12	No. ST5—Sizes	6/0	5/0	4/0	3/0	2/0	1/0	1 to 8
Weight per 1000, lbs.	3	2 1/4	2	2	1 3/4	1 1/4	%	Weight per 1000, lbs.	6 1/2	2 3/4	2	1 3/4	1 1/4	1 1/4	%
Thousand	\$2.70	2.40	2.20	1.80	1.50	1.30	1.10	Thousand	\$3.70	3.50	3.20	2.90	2.50	2.20	1.90

Packed, 100 in box; 1,000 in carton.

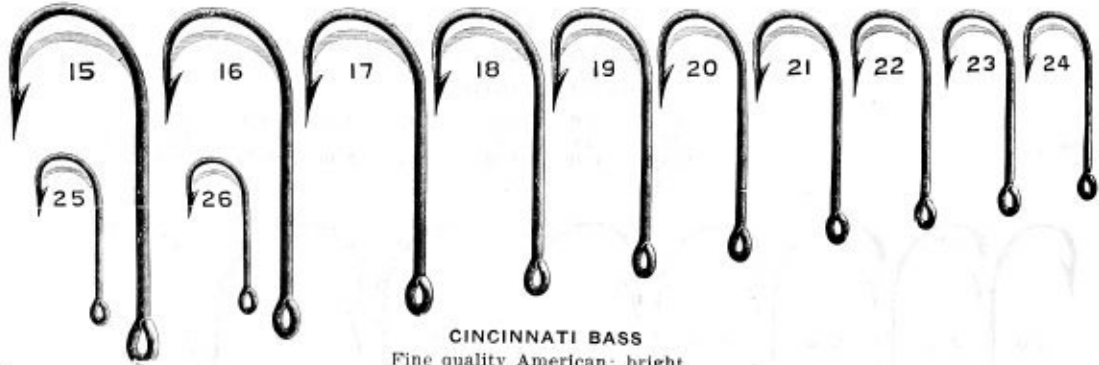

CINCINNATI BASS

Fine quality American; bright.

No. ST6CB—Sizes	16	17	18	19	20	21	22	23	24	25
Weight per 1000, lbs.	3 1/2	2 3/4	2	1 1/2	1 1/4	1	1	3/4	3/4	3/4
Thousand	\$3.00	2.40	2.20	1.90	1.50	1.20	1.10	1.10	1.10	1.10
Best quality English; spear point.										
No. ST23H—Sizes	16	17	18	19	20	21	22	23	24	25
Weight per 1000, lbs.	3 1/2	2 3/4	2	1 1/2	1 1/4	1	1	3/4	3/4	3/4
Thousand	\$4.50	4.00	3.00	2.60	2.30	2.00	2.00	2.00	2.00	2.00
Best quality English; hollow point.										
No. ST24H—Sizes	16	17	18	19	20	21	22	23	24	25
Weight per 1000, lbs.	3 1/2	2 3/4	2	1 1/2	1 1/4	1 1/4	1	3/4	3/4	3/4
Thousand	\$12.00	10.50	9.50	8.00	7.00	6.00	6.00	6.00	6.00	6.00

Packed, 100 in box; 1000 in carton.

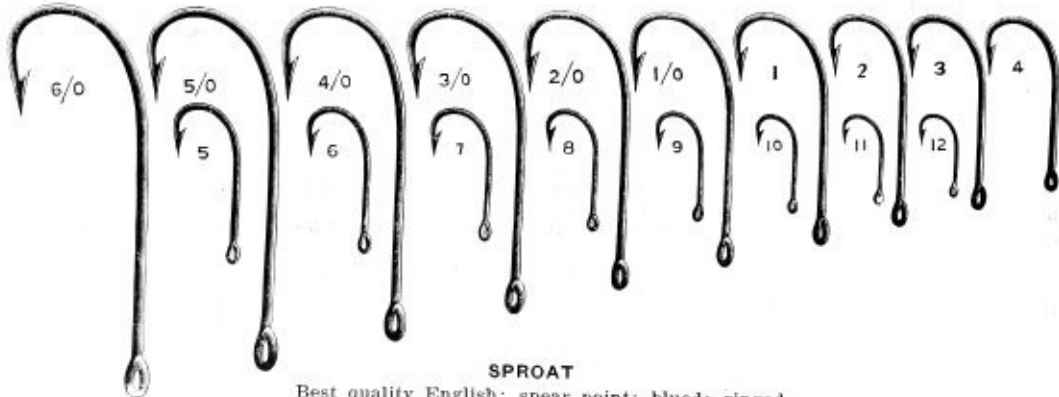

SPROAT

Best quality English; spear point; blued; ringed.

No. ST8S—Sizes	5/0	4/0	3/0	2/0	1/0	1 to 9
Weight per 1000, lbs.	2 1/4	1 3/4	1 3/4	1 1/2	1	3/4
Thousand	\$3.50	3.20	2.90	2.50	2.20	1.90

Packed, 100 in box; 1000 in carton.

FISHING HOOKS

RINGED

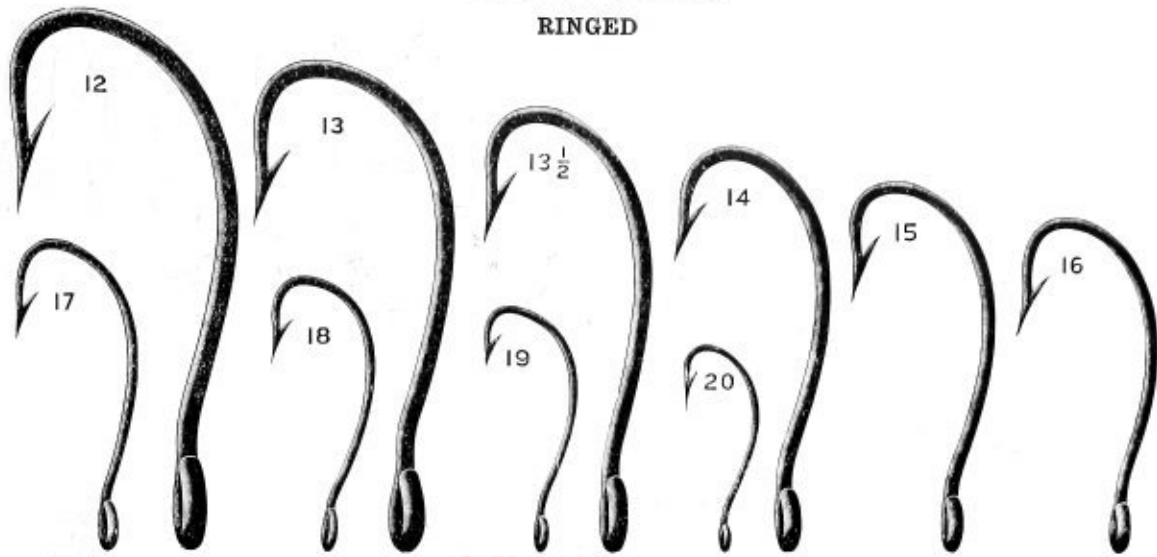

CENTRAL DRAUGHT COD
American; japped.

No. ST7CD—Sizes	17	16	15	14	13	12	11	10
Weight per 1000, lbs.	$\frac{1}{4}$	$\frac{1}{2}$	$\frac{5}{8}$	$\frac{7}{8}$	$1\frac{1}{4}$	$1\frac{3}{8}$	$2\frac{3}{8}$	4
Gross	\$0.40	.50	.60	.70	1.00	1.20	1.50	1.80

Packed, one gross in box.

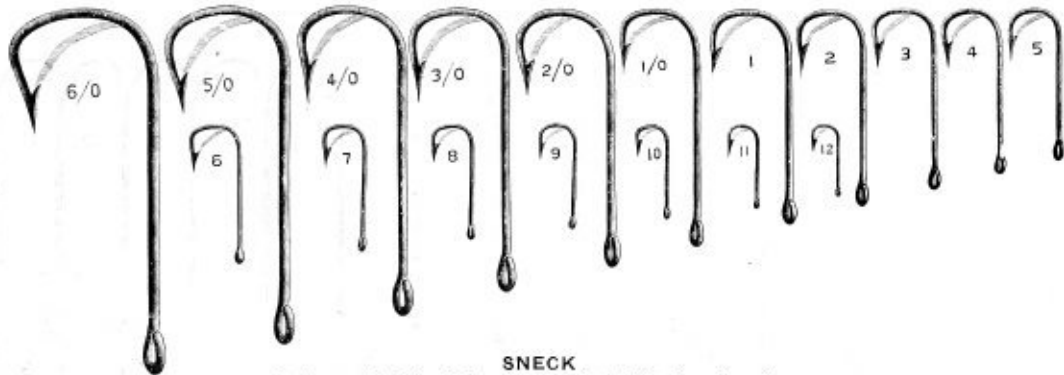

SNECK

Best quality English; spear point; blued; ringed.

No. ST9S—Sizes	6/0	5/0	4/0	3/0	2/0	1/0	1 to 10
Weight per 1000, lbs.	$3\frac{3}{4}$	$2\frac{3}{4}$	$2\frac{1}{2}$	$1\frac{1}{2}$	1	$\frac{7}{8}$	$\frac{5}{8}$
Thousand	\$4.50	4.00	3.80	3.10	2.50	2.20	2.00

Packed, 100 in box; 1000 in carton.

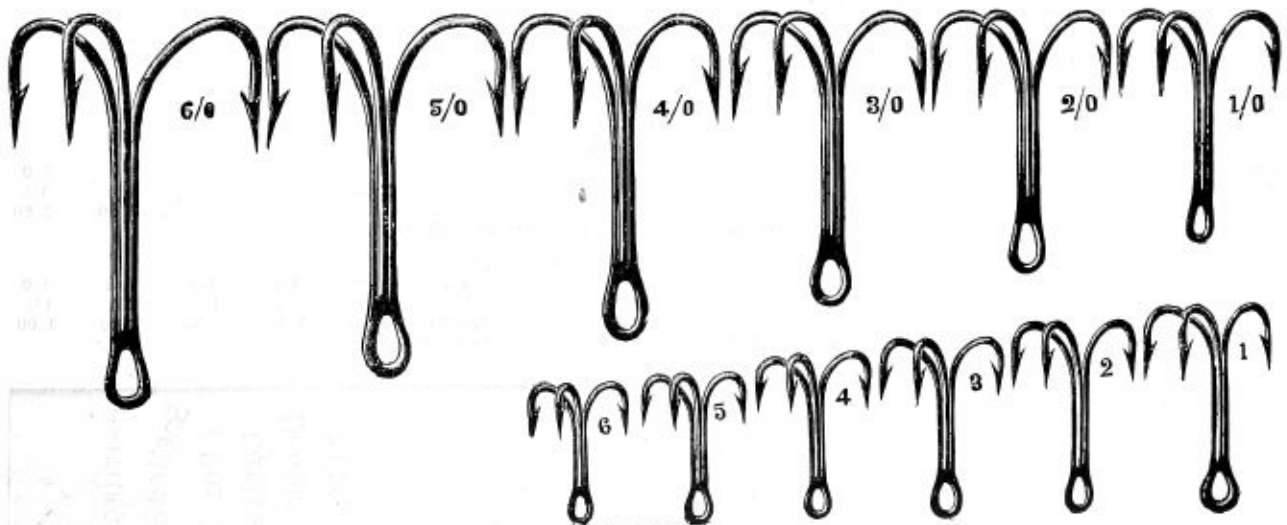

TREBLE

Spear point; bronzed.

No. ST11T—Sizes	6/0	5/0	4/0	3/0	2/0	1/0	1	2	3	4	5
Weight per gross, lbs.	2	$1\frac{1}{2}$	1	$\frac{7}{8}$	$\frac{3}{4}$	$\frac{1}{2}$	$\frac{7}{8}$	$\frac{3}{8}$	$\frac{1}{8}$	$\frac{1}{8}$	$\frac{1}{4}$
Gross	\$5.20	4.50	4.00	3.70	3.00	2.80	2.50	2.50	2.50	2.50	2.50

Packed, one-half gross in box.

FISHING HOOKS

SNELLED

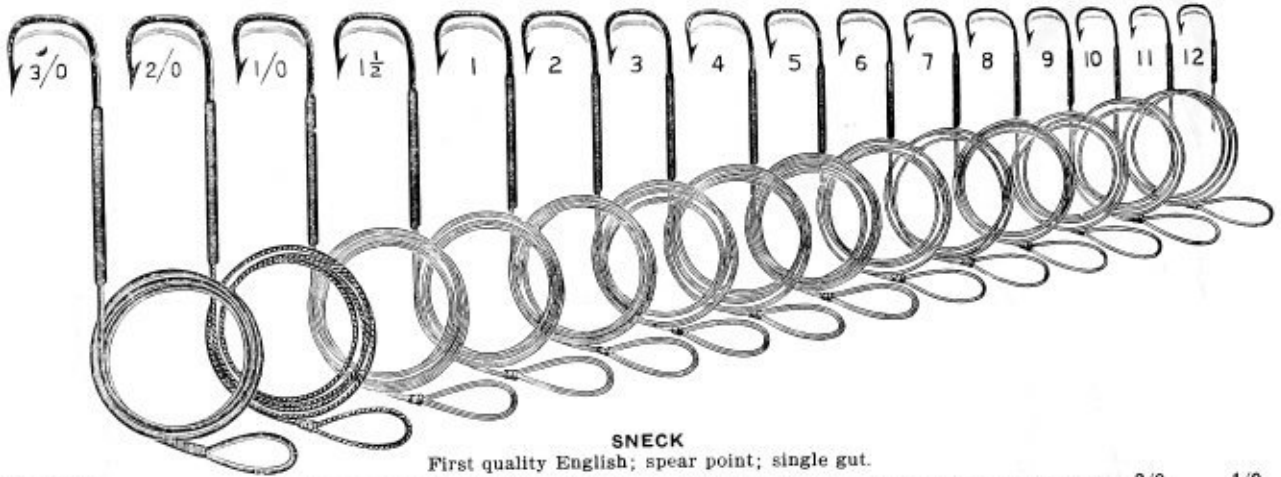

SNECK

First quality English; spear point; single gut.

No. ST15S—Sizes	2/0	1/0	1 to 10
Weight per gross, lbs.	1 1/2	1 1/4	1 1/4
Gross	\$2.50	2.50	2.00

Packed, one-twelfth gross in package; one gross in box.

First quality English; spear point; double gut.

No. ST16S—Sizes	6/0	5/0	4/0	3/0	2/0	1/0	1 to 6
Weight per gross, lbs.	1 1/2	1 1/4	1 1/4	1 1/4	1 1/4	1 1/4	1 1/4
Gross	\$4.00	3.70	3.50	3.50	3.00	3.00	2.70

Packed, one-twelfth gross in package; one gross in box.

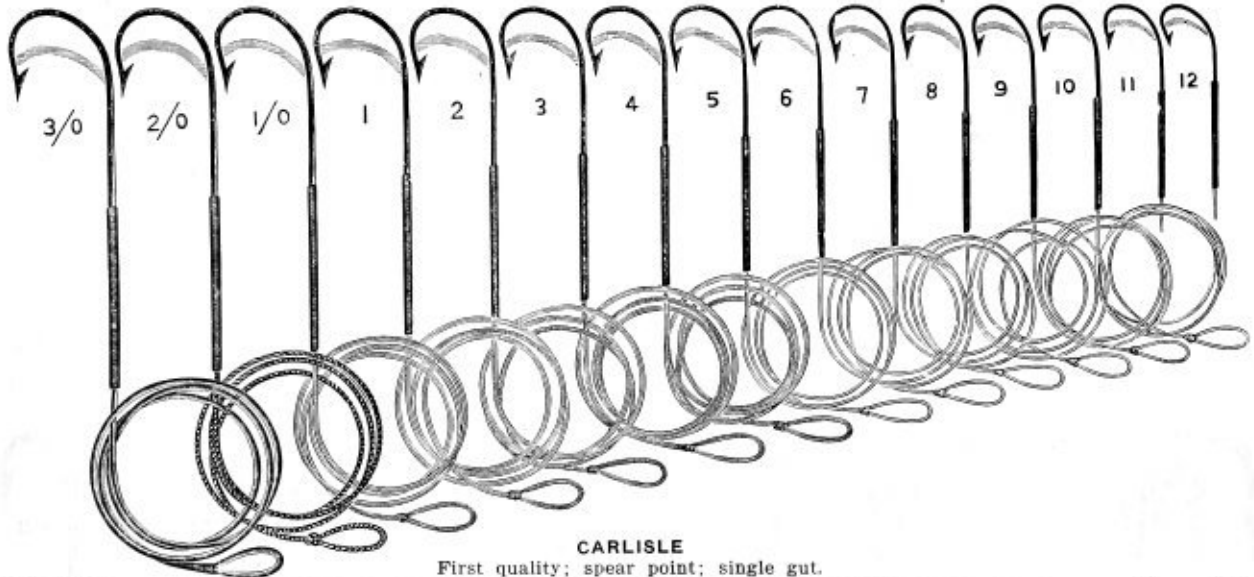

CARLISLE

First quality; spear point; single gut.

No. ST13CH—Sizes	2/0	1/0	1 to 10
Weight per gross, lbs.	1 1/2	1 1/4	1 1/4
Gross	\$2.50	2.50	2.00

Packed, one-twelfth gross in package; one gross in box.

First quality; spear point; double gut.

No. ST14C—Sizes	6/0	5/0	4/0	3/0	2/0	1/0	1 to 10
Weight per gross, lbs.	1 1/2	1 1/4	1 1/4	1 1/4	1 1/4	1 1/4	1 1/4
Gross	\$4.00	3.70	3.50	3.50	3.00	3.00	2.70

Packed, one-twelfth gross in package; one gross in box.



Showing method of packing snelled hooks.

FISHING HOOKS

SNELLED

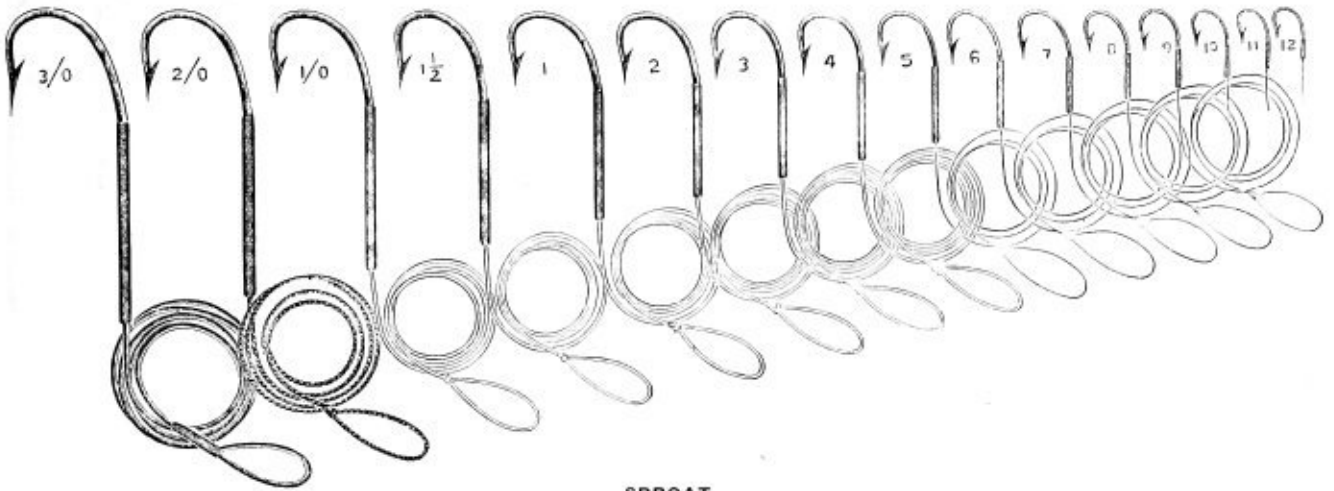

SPROAT

First quality; spear point; single gut.

No. ST17S—Sizes	2/0	1/0	1 to 10
Weight per gross, lbs.	1 1/2	1 1/2	1 1/2
Gross	\$2.50	2.50	2.00

Packed, one-twelfth gross in package; one gross in box.

First quality; spear point; double gut.

No. ST18S—Sizes	6/0	5/0	4/0	3/0	2/0	1/0	1 to 6
Weight per gross, lbs.	1 1/4	1 1/4	1 1/4	1 1/2	1 1/2	1 1/2	1 1/2
Gross	\$4.00	3.70	3.50	3.50	3.00	3.00	2.70

Packed, one-twelfth gross in package; one gross in box.

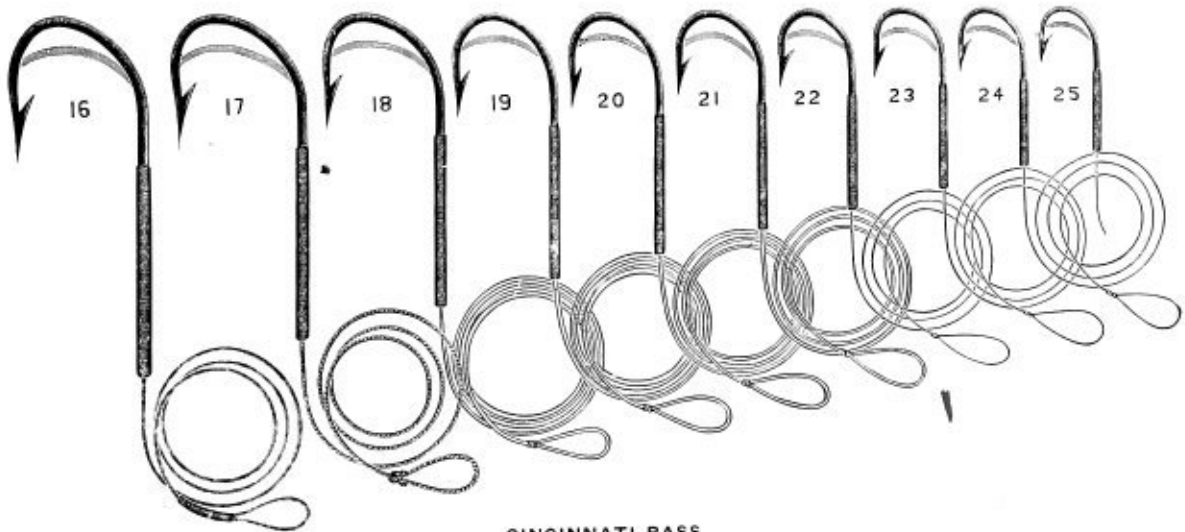

CINCINNATI BASS

First quality; spring steel; double gut.

No. ST19S—Sizes	16	17	18	19	20	21	22	23	24	25	26
Weight per gross, lbs.	1 1/2	1 1/2	1 1/4	1 1/2	1 1/2	1 1/2	1 1/2	1 1/2	1 1/2	1 1/2	1 1/2
Gross	\$4.00	3.70	3.50	3.50	3.00	3.00	2.70	2.70	2.70	2.70	2.70

Packed, one-half dozen in package; one gross in box.

FISHING HOOKS

SNELLED

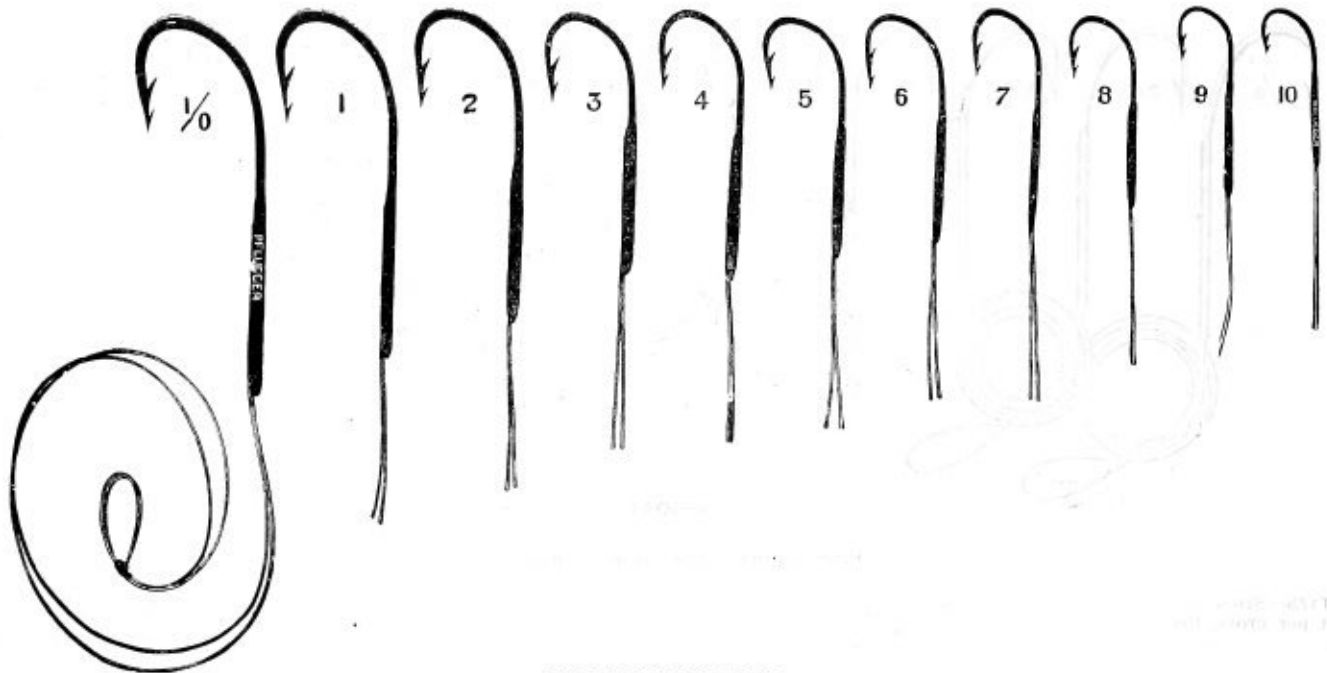

CATCH THE NIBBLER

New York Trout Pattern; double barb; single gut.

No. ST21C—Sizes	5	6 to 10
Gross	\$3.50	3.50
Packed, one gross in box.		

New York Trout Pattern; double barb; double gut.

No. ST22C—Sizes	1/0	1	2	3	4	5	6 to 10
Gross	\$7.00	6.60	5.70	5.20	5.00	4.50	4.00
Packed, one gross in box.							

COMPARISON OF CATCH THE NIBBLER HOOK SIZES WITH SPROAT HOOK SIZES

Catch the Nibbler sizes	Nos. 1/0	1	2	3	4	5	6	7	8	9	10
Sproat sizes	Nos. 5/0	4/0	3/0	2/0	1/0	1	2	3	4	5	6

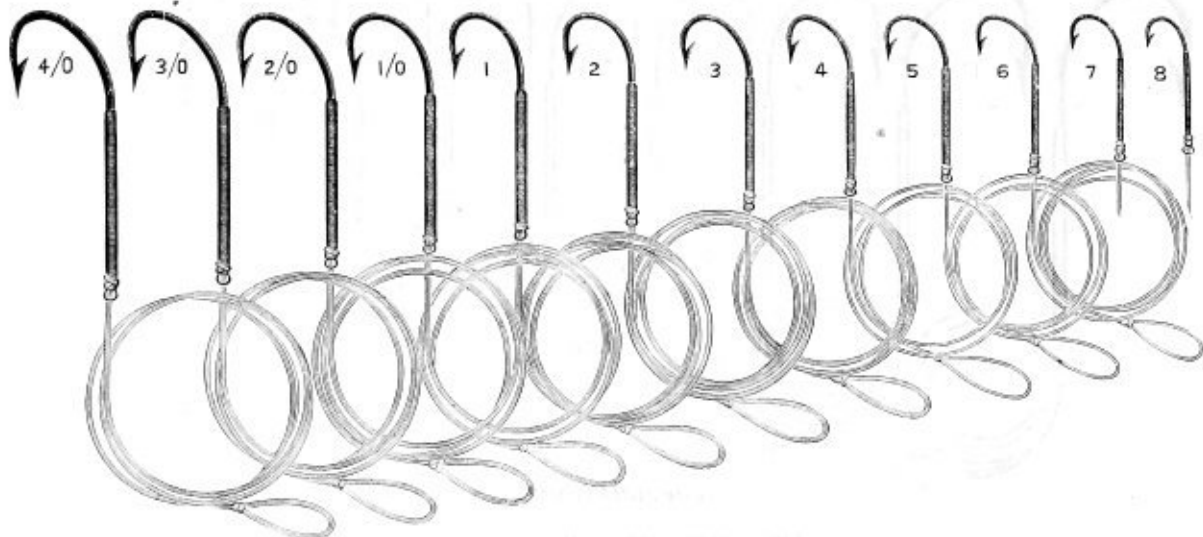

PENNELL

Extra fine quality, English elastic spring steel, bronzed; Cholmondeley turn-down eye; double gut.

No. ST20P—Sizes	3/0	2/0	1/0	1	2	3	4	5
Weight per gross, lbs.	1 1/4	1 1/8	1 1/8	1 1/8	1 1/4	1 1/4	1 1/4	1 1/4
Gross	\$6.50	6.00	5.90	5.60	5.60	5.60	5.60	5.60
Packed, one-half dozen in package; one gross in box.								

RUBBER BAITS



GRASSHOPPERS

No. ST1029—Soft rubber body; 1¾ inches long; painted in natural colors; sroat hook; hollow point bronzed; tied on single gut snells; brass box swivel; weight per dozen 4 oz.\$ 3.20
Packed, one on card; one dozen in box.



DOBSONS

No. ST1026—Soft rubber body; 2½ inches long; painted in natural colors; sroat hook; hollow point, bronzed; tied on silk gimp; brass box swivel; weight per dozen 3 oz. \$ 3.40
Packed, one on card; one dozen in box.



FROGS

No. ST1027—Soft rubber body; 1½ inches long; painted in natural colors; treble hook; file point, bronzed; tied to silk gimp loop; brass box swivel; weight per dozen 6 oz.\$ 4.00
Packed, one on card; one dozen in box.



CRAWFISH

No. ST1031—Soft rubber body; 2½ inches long; painted in natural colors; treble hook; hollow point bronzed; tied in single gut snell; brass box swivel; weight per dozen 6 oz.\$ 4.00
Packed, one on card; one dozen in box.

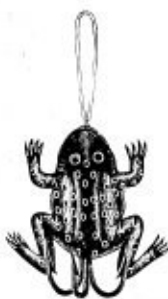

FROGGIES

No. ST1028—Soft rubber body; ¾-inch long; painted in natural colors; treble hook; file point, bronzed; tied to silk gimp loop; weight per dozen 3 oz.\$ 3.00
Packed, one dozen on card in box.



GRASSHOPPERS

No. ST1030—Soft rubber body; 1¼ inches long; painted in natural colors; sroat hook; hollow point, bronzed; tied on single gut snell; weight per dozen 2 oz.\$ 2.00
Packed, one dozen on card.



ANGLE WORMS

No. ST227—Soft rubber body; 2¾ inches long; painted in natural colors; three sroat hooks; hollow point, bronzed; tied on double gut snell; brass box swivel; weight per dozen 3 oz.\$ 3.60
Packed, one-half dozen on card; one dozen in box.

RUBBER FROGS



Soft pliable rubber; naturally painted; durable and life-like; weedless.

No. ST1002F—Weight per dozen 1¼ lbs.\$ 5.50
Packed, one on card; one dozen in box.

ARTIFICIAL BAITS

HEDDON WOODEN MINNOWS

These baits are for casting, trolling or skittering and are wonderfully successful on all species of game fishes; every minnow is coated with from seven to twelve coats of special Dowagiac porcelain enamel; guaranteed not to peel; all metal parts are nickel plated; the highest class artificial baits on the market.



- No. ST150M—Fancy green back; white belly; length 3¾ inches; weight per dozen 3 lbs.\$13.60
- No. ST151M—Rainbow colors consisting of green back; pink and yellow sides and white belly; otherwise same as No. ST150M 13.60
- No. ST152M—White body with slate colored back; otherwise same as No. ST150M..... 13.60

- No. ST154M—Red body with dark green back; yellow belly; reddish sides; fancy sienna back; otherwise same as No. ST150M\$13.60
- No. ST159A—Yellow perch; otherwise same as No. ST150M... 13.60
- No. ST159B—Green spotted imitation frog colors; otherwise same as No. ST150M 13.60

Packed, one in box.

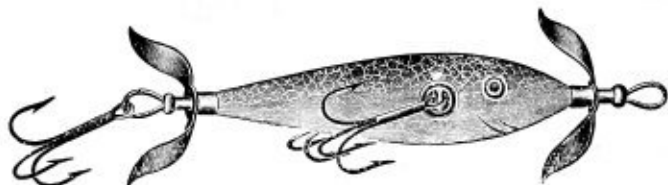

- No. ST100M—Fancy green back; white belly; length of body 2¾ inches; weight per dozen 3 lbs.\$12.00
- No. ST101M—Rainbow colors, consisting of green back, pink and yellow sides and white belly; otherwise same as No. ST100M 12.00
- No. ST102M—White body with slate colored back; otherwise same as No. ST100M..... 12.00
- No. ST104M—Red body with dark green back; otherwise same as No. ST100M..... 12.00
- No. ST109A—Yellow perch; otherwise same as No. ST100M... 12.00
- No. ST109B—Green spotted imitation frog colors; otherwise same as No. ST100M 12.00

Packed, one in box.

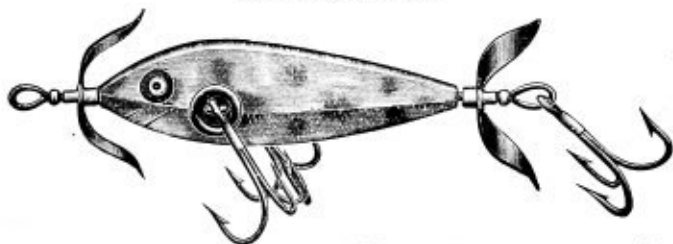

- No. ST0M—White body; mottled and decorated with red and green; length of body 3 inches; weight per dozen 2 lbs.\$12.00
- No. ST01M—Yellow body; mottled and decorated with red and green; otherwise same as No. ST0M..... 12.00
- No. ST02M—Red body; mottled and decorated in dark green; otherwise same as No. ST0M..... 12.00

SWIMMING

- No. ST900M—White body with green and red decorations; length of body 4½ inches; weight per dozen 2½ lbs.\$12.00
- No. ST901M—Yellow body with green and red decorations; length of body 4½ inches; weight per dozen 2½ lbs. 12.00

Packed, one in box.



- No. ST200M—White body; blue head; red collar; three treble hooks; length of body 4¾ inches; weight per dozen 2½ lbs.\$13.60
- No. ST201M—Entire bait is grass green and spotted; otherwise same as No. ST200M 13.60
- No. ST200L—Luminous body; red head; otherwise same as No. ST200M 16.00

Packed, one in box.

DECKER SURFACE

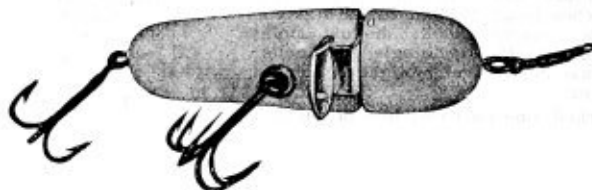

Made of soft wood; tapered, with rounded body and ends; finished smooth; fitted with metal disc spinners; armed with three gangs of hooks, which may be single or treble as desired; painted by patent process in either white, yellow or yellow mottled color; especially designed for trolling for large fish.

- No. ST122B—White; length 3½ inches; weight per dozen 2½ lbs.\$ 8.00
- No. ST123B—Yellow; otherwise same as No. ST122B..... 8.00
- No. ST124B—Yellow mottled; otherwise same as No. ST122B.. 8.00

Packed, one in box.

SOUTH BEND



- No. ST923—Woodpecker; surface minnow; white body; red head; length 4½ inches; weight per dozen 3½ lbs.\$ 6.00

Packed, one in box.



- No. ST913—Panetella; slender shape underwater minnow; green cracked back; white belly; length 4¼ inches; weight per dozen 3½ lbs.\$ 9.24

Packed, one in box.

ARTIFICIAL BAITS

WOODEN MINNOWS

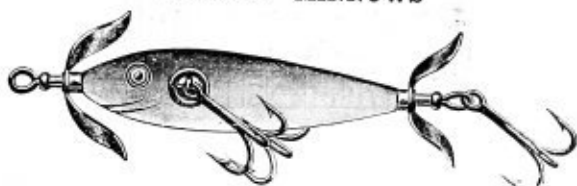

Nickel plated spinners; three treble hooks; glass eyes.

- | | | |
|---|------|---------|
| No. ST501M—Green and white; body 2¾ inches long; weight per dozen 2 lbs. | Doz. | \$ 5.50 |
| No. ST502M—Yellow perch; otherwise same as No. ST501M.... | | 5.50 |
| No. ST503M—Spotted or mottled; otherwise same as No. ST501M | | 5.50 |
| No. ST504M—Fancy rainbow; otherwise same as No. ST501M.. | | 5.50 |
| No. ST505M—Red; otherwise same as No. ST501M..... | | 5.50 |
- Packed, one in box.

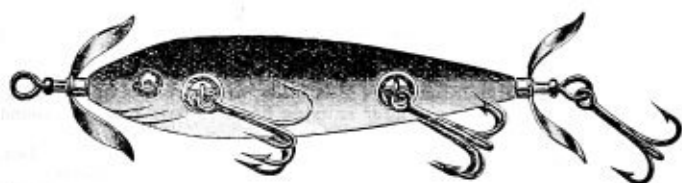

Nickel plated spinners; five treble hooks; glass eyes.

- | | | |
|---|------|---------|
| No. ST601M—Green and white; body 3¾ inches long; average weight per dozen 3 lbs. | Doz. | \$ 6.00 |
| No. ST602M—Yellow perch; otherwise same as No. ST601M.... | | 6.00 |
| No. ST603M—Spotted or mottled; otherwise same as No. ST601M | | 6.00 |
| No. ST604M—Fancy rainbow; otherwise same as No. ST601M.. | | 6.00 |
| No. ST605M—Red back; white belly; otherwise same as No. ST601M | | 6.00 |
- Packed, one in box.

CHARMER MINNOWS

The Charmer minnow is made in two sections; the forward section is stationary, while the rearward section with spiral stripes revolves in the water, blending the colors and creating a beautiful effect: three treble hooks; solid German silver spinners.



- | | | |
|---|------|---------|
| No. ST401M—Yellow head; green and yellow striped body; weight per dozen 2½ lbs. | Doz. | \$13.60 |
| No. ST402M—Yellow head; red and yellow striped body; otherwise same as No. ST401M | | 13.60 |
| No. ST403M—Green head; green and white striped body; otherwise same as No. ST401M | | 13.60 |
| No. ST404M—Red head; red and white striped body; otherwise same as No. ST401M | | 13.60 |
| No. ST405M—White head; red and white striped body; otherwise same as No. ST401M | | 13.60 |
| No. ST406M—White head; green and white striped body; otherwise same as No. ST401M | | 13.60 |
| No. ST407M—Gold head; green and gold striped body; otherwise same as No. ST401M | | 13.60 |
| No. ST408M—Gold head; golden and red striped body; otherwise same as No. ST401M | | 13.60 |
- Packed, one in box.

KENT CHAMPION FLOATER



Made of red cedar; light and buoyant; enameled in grass green with rainbow stripes and dots; white belly.

- | | | |
|---|------|---------|
| No. ST42—Size 2½x1¾ inches; two spinners revolving in opposite directions; three detachable treble hooks; weight per dozen 9 oz. | Doz. | \$ 8.00 |
|---|------|---------|

Packed, one in box.

MINNOW ASSORTMENTS

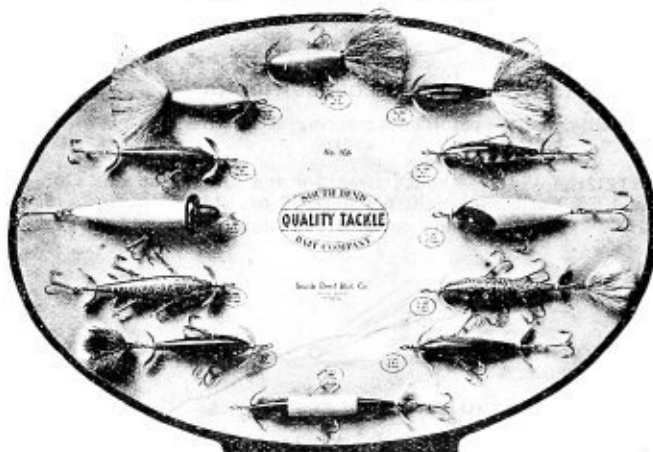

SOUTH BEND

- | | | |
|---|-------|---------|
| No. ST358M—Casting and trolling; consists of one dozen single and double spinner minnows, with from one to five treble hooks; bodies of selected red cedar, specially treated and waterproofed; finished with many coats of enamel beautifully blended in a variety of colors; will not crack or peel; spinners, hooks and mountings heavily nickel plated; weight per assortment 4 lbs. | Asst. | \$ 7.16 |
|---|-------|---------|

Packed, one assortment on display easel.

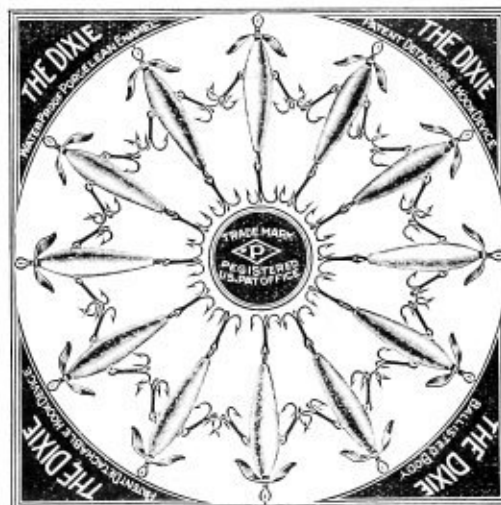

DIXIE

- | | | |
|---|-------|---------|
| No. ST506M—Consists of one dozen single spinner minnows; with three treble hooks; assorted colors; length 2½ inches; well made and will give satisfaction; same quality as No. ST501M; weight per dozen 3 lbs. | Asst. | \$ 2.50 |
|---|-------|---------|

Packed, one dozen on attractive display card.

COAXER SURFACE BAITS

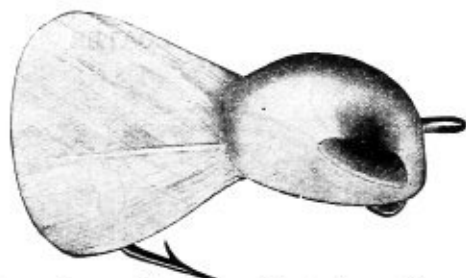

A positively weedless surface bait; white body; red fins and feathers; finest quality steel hook; a very successful clear water lure.

- No. ST120B—Coaxer, size 1; weight per dozen 1 1/4 lbs. Doz. \$ 8.40
 - No. ST121B—Coaxer, size 2; weight per dozen 1 1/4 lbs. 8.40
- Packed, one in box.

LUTZ PORK BAIT



Wiggles like a minnow.

Anglers of experience know full well the value of a life-like lure; know the bait which will most naturally imitate the wiggle and flash of the minnow is the one which will get the fish; will keep indefinitely; packed in bottles.

- No. ST10B—Put up in bottle; weight per dozen 9 lbs. Doz. \$ 6.00
- Packed, one dozen in box.

CASTING SUNDRIES

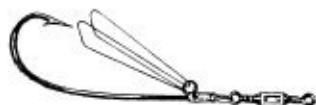

U. B. WEEDLESS HOOKS

Best quality, hollow point hook; spring steel wire guards, with brass swivel.

- No. ST212H—Weedless hook; sizes 3/0 and 5/0 sproat and 4/0 and 6/0 Carlisle; weight per dozen 3 oz. Doz. \$ 2.50
- Packed, one on card, one dozen in box.



U. B. WEEDLESS HOOKS

With Weights

Best quality, hollow point hooks; spring steel wire guards; brass swivel.

- No. ST222H—Sizes 3/0 and 5/0 sproat and 4/0 and 6/0 Carlisle; weight per dozen 5 oz. Doz. \$ 3.50
- Packed, one on card, one dozen in box.



Cut showing about half actual size

U. B. FROG HARNESS

Best quality music wire; nickel plated; extra quality file point hooks; holds the frog without hooking and keeps it alive.

- No. ST201H—Sizes 4/0 Sproat style front hook and 6/0 Carlisle rear hook; weight per dozen 6 oz. Doz. \$ 6.00
- Packed, one on card; one dozen in box.



U. B. TANDEMS

Best quality steel hollow point hooks; fine music wire; looped clamp for holding minnow in position; copper plated to prevent rust.

- No. ST202T—Sizes 3/0 Sproat style front hook and 4/0 Carlisle rear hook; weight per dozen 6 oz. Doz. \$ 6.00
- Packed, one on card; one dozen in box.



TOOLEY WEEDLESS HOOKS

The long weed guard insures flexibility at the point of the hook, the circular band acts as a fender causing hook to pass over or around obstacles.

- No. ST230H—Sizes 3/0 and 4/0 sneck hooks; weight per dozen 3 oz. Doz. \$ 1.30
 - No. ST231H—Sizes 4/0 and 5/0 sproat hooks; weight per dozen 3 oz. 1.30
- Packed, one on card, one dozen in box.



TOOLEY WEEDLESS HOOKS

With lead weights

The long weed guard insures flexibility at the point of the hook, the circular band acts as a fender causing hook to pass over or around obstacles.

- No. ST232H—Sizes 3/0 and 4/0 sneck hooks; weight per dozen 5 oz. Doz. \$ 1.50
 - No. ST233H—Sizes 4/0 and 5/0 sproat hooks; weight per dozen 5 oz. 1.50
- Packed, one on card, one dozen in box.



Cut half actual size.

U. B. SPIN FLIES

Weedless hook; colored celluloid spinner; colored beads.

- No. ST205H—White, blue or red wing splaners; weight per dozen 5 oz. Doz. \$ 4.30
- Packed, one on card; one dozen in box.



The Prescott Spinner

Used with equal success upon stream or lake

An Unequaled Bass-Killer

Manufactured by Chas. B. Spaul, Prescott, Wis.

PRESCOTT SPINNERS

For casting, trolling or still fishing; nickel plated steel wire; will not rust or tangle; fish cannot bite it off; brass box swivel; snap to attach sinker when wanted.

- No. ST408H—Hollow point Cincinnati bass hook; nickel plated brass spoons; weight per dozen 6 oz. Doz. \$ 4.00
- Packed, one on card; one dozen in box.

CASTING SUNDRIES



Actual size No. ST1461

FREE SPINNERS

Full nickel plated blades; mounted on rust-proof music wire shaft; made for use with any style fly or hook.

No. ST1461—Single; weight per dozen 2½ oz. Doz. \$ 1.70
Packed, one on card; one dozen in box.



Actual size No. ST1471

FREE SPINNERS

Full nickel plated blades; mounted on rust-proof music wire shaft; made for use with any style fly or hook.

No. ST1471—Double; weight per dozen 3 oz. Doz. \$ 2.80
Packed, one on card; one dozen in box.



EMERICK SPINNERS

Nickel outside; copper inside of blade; box swivel.

No. ST106—Sizes 2, 3 and 4; weight per dozen 2½ oz. Doz. \$ 1.50
Packed, one on card; one dozen in box.

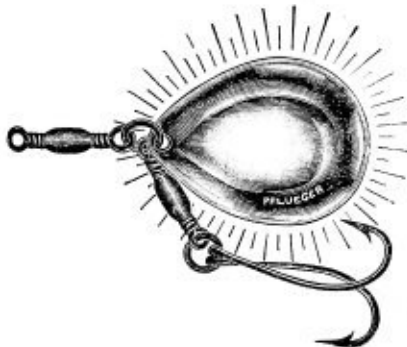
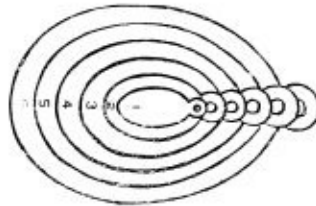

BRIGAND SPINNERS

Two brass barrel swivels; two best quality bronzed hollow point hooks.

No. ST1006—Nickel finish; size 1 or 2; weight per dozen 4 oz. Doz. \$ 2.00
No. ST1007—Copper finish; size 1 or 2; weight per dozen 4 oz. Doz. 2.00
Packed, one on card; one dozen in box.

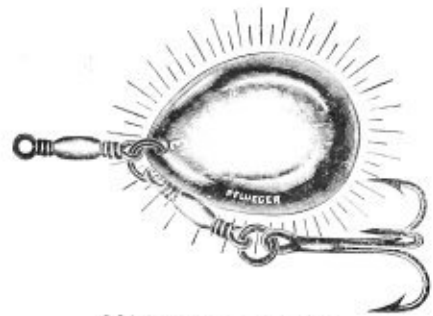
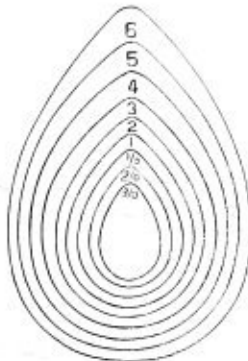

COLORADO SPINNERS

Brass box swivels; hollow point hooks.

Metal Blades

No. ST1000—All copper blades; sizes 4, 3, 2, 1, 1/0 and 2/0; weight per dozen 4 oz. Doz. \$ 1.60
No. ST1001—All brass blades; otherwise same as No. ST1000. Doz. 1.60
No. ST1002—Planished outside, copper inside blades; sizes 1, 1/0 and 2/0; weight per dozen 4 oz. Doz. 1.60
Packed, one on card; one dozen in box.

Pearl Blades

No. ST1005—Sizes 2, 1, 1/0 and 2/0; weight per dozen 3 oz. Doz. \$ 2.30
No. ST1005—Size 3; weight per dozen 3 oz. Doz. 3.00
Packed, one on card; three dozen in box.

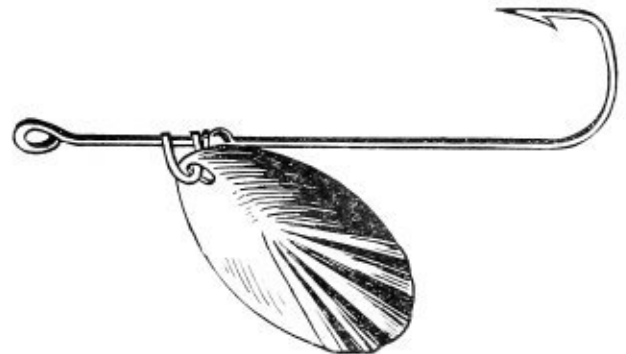

CASTING SPOONS

Nickel blade; best quality bronzed sneek hook; for frogs, minnows or pork bait.

No. ST404—Size 4/0 hook; weight per dozen 3 oz. Doz. \$ 2.00
No. ST405—Size 5/0 hook; weight per dozen 3 oz. Doz. 2.00
Packed, one on card; one dozen in box.

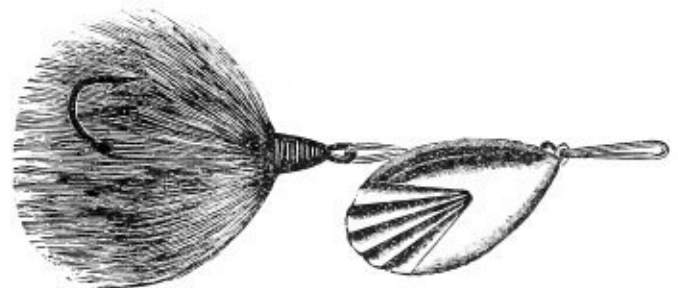

BUCKTAIL CASTING SPOONS

Concave side of blade painted red; convex side nickel plated; single bronzed sproat hook.

No. ST1185—Size spoon, inches. Doz. 4½ 4¾
Size, hook, inches Doz. 1/2 2/0
Weight per dozen, oz. Doz. 8 8
Dozen Doz. \$2.80 2.80
Packed, two on card; one dozen in box.

SPINNERS AND CASTING SPOONS

TROUT

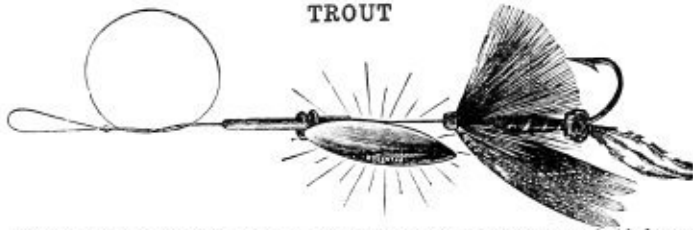

Nickel; fancy fly; gut leader; sizes 8 small, 9 medium and 10 large.

- | | | |
|-------------|--|--------------|
| No. ST109C | —Coachman; weight per dozen 4½ oz. | Doz. \$ 1.80 |
| No. ST109RC | —Royal Coachman; weight per dozen 4½ oz. | 1.80 |
| No. ST109GH | —Gray hackle; weight per dozen 4½ oz. | 1.80 |
| No. ST109BH | —Brown hackle; weight per dozen 4½ oz. | 1.80 |
- Packed, one on card; one dozen in box.



GENUINE HILDEBRANDT SINGLE TROUT

Nickel plated blades; hollow point hooks; fancy feather fly.

- | | | |
|-------------|---|--------------|
| No. ST176RC | —Royal Coachman; weight per dozen 3 oz. | Doz. \$ 4.00 |
| No. ST176C | —Coachman; weight per dozen 3 oz. | 4.00 |
| No. ST176GH | —Gray Hackle; weight per dozen 3 oz. | 4.00 |
| No. ST176P | —Professor; weight per dozen 3 oz. | 4.00 |
| No. ST176BH | —Brown Hackle; weight per dozen 3 oz. | 4.00 |
| No. ST176BG | —Black Gnat; weight per dozen 3 oz. | 4.00 |
- Packed, one on card; one dozen in box.

BASS

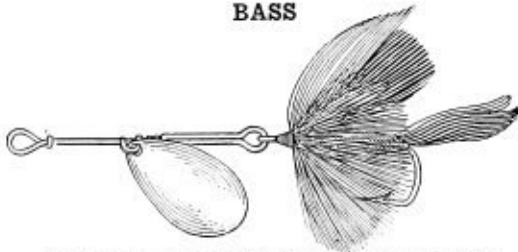

GENUINE HILDEBRANDT, SINGLE BASS

Nickel plated blades; No. 1 spinner on No. 1, and No. 2 spinner on No. 2; sneck hollow point hooks; fancy feather fly.

- | | | |
|-------------|--|--------------|
| No. ST175RI | —No. 1 Red Ibis; weight per dozen 4 oz. | Doz. \$ 4.00 |
| No. ST175PB | —No. 1 Parmachenee Belle; weight per dozen 4 oz. | 4.00 |
| No. ST175C | —No. 1 Coachman; weight per dozen 4 oz. | 4.00 |
| No. ST175BT | —No. 1 Buck Tail; weight per dozen 4 oz. | 3.50 |
| No. ST175LB | —No. 1 Lord Baltimore; weight per dozen 4 oz. | 4.80 |
| No. ST177RI | —No. 2 Red Ibis; weight per dozen 4 oz. | 4.00 |
| No. ST177PB | —No. 2 Parmachenee Belle; weight per dozen 4 oz. | 4.00 |
| No. ST177SD | —No. 2 Silver Doctor; weight per dozen 4 oz. | 4.80 |
| No. ST177LB | —No. 2 Lord Baltimore; weight per dozen 4 oz. | 4.80 |
| No. ST177BT | —No. 2 Buck Tail; weight per dozen 4 oz. | 3.50 |
- Packed, one on card; one dozen in box.

BASS

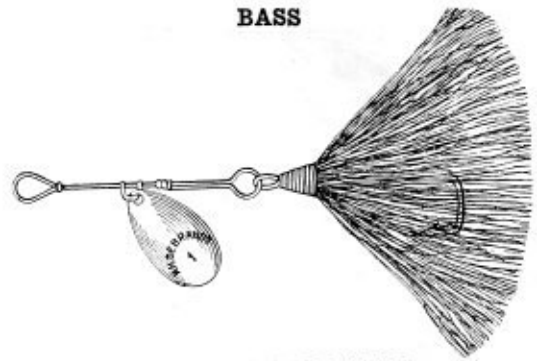

GENUINE HILDEBRANDT

Single bass spinner; nickel plated blades; No. 3 spinner; No. 1/0 Sneck hollow point hooks; fancy feather fly.

- | | | |
|-------------|--|--------------|
| No. ST178BT | —Buck Tail; weight per dozen 5 oz. | Doz. \$ 3.50 |
| No. ST178RI | —Red Ibis; weight per dozen 5 oz. | 4.00 |
| No. ST178SD | —Silver Doctor; weight per dozen 5 oz. | 4.80 |
| No. ST178LB | —Lord Baltimore; weight per dozen 5 oz. | 4.80 |
| No. ST178PB | —Parmachenee Belle; weight per dozen 5 oz. | 4.00 |
| No. ST178SG | —Seth Green; weight per dozen 5 oz. | 4.00 |
- Packed, one on card; one dozen in box.

Single; pearl blade; No. 3 spinner; No. 1/0 sneck hollow point hooks; fancy feather fly.

- | | | |
|-------------|---|--------------|
| No. ST174BT | —Buck Tail; weight per dozen 5 oz. | Doz. \$ 5.00 |
| No. ST174LB | —Lord Baltimore; weight per dozen 5 oz. | 7.00 |
| No. ST174C | —Coachman; weight per dozen 5 oz. | 5.50 |
| No. ST174RI | —Red Ibis; weight per dozen 5 oz. | 5.50 |
- Packed, one on card; one dozen in box.

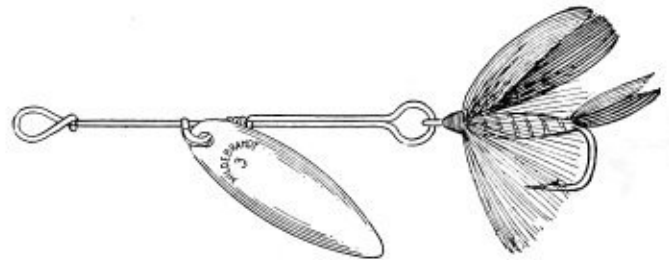

GENUINE HILDEBRANDT

Single Slim Eli spinners; nickel plated blades; the long slim blades resemble a shiner in the water; No. 2 with No. 2, and No. 3 with No. 1/0 hollow point Sneck hook.

- | | | |
|-------------|---|--------------|
| No. ST179RC | —No. 2 Royal Coachman; weight per dozen 5 oz. | Doz. \$ 4.00 |
| No. ST179BH | —No. 2 Brown Hackle; weight per dozen 5 oz. | 4.00 |
| No. ST179BG | —No. 2 Black Gnat; weight per dozen 5 oz. | 4.00 |
| No. ST179BT | —No. 2 Buck Tail; weight per dozen 5 oz. | 3.50 |
| No. ST180RC | —No. 3 Royal Coachman; weight per dozen 5 oz. | 4.00 |
| No. ST180BH | —No. 3 Brown Hackle; weight per dozen 5 oz. | 4.00 |
| No. ST180BG | —No. 3 Black Gnat; weight per dozen 5 oz. | 4.00 |
| No. ST180BT | —No. 3 Buck Tail; weight per dozen 5 oz. | 3.50 |
- Packed, one on card; one dozen in box.

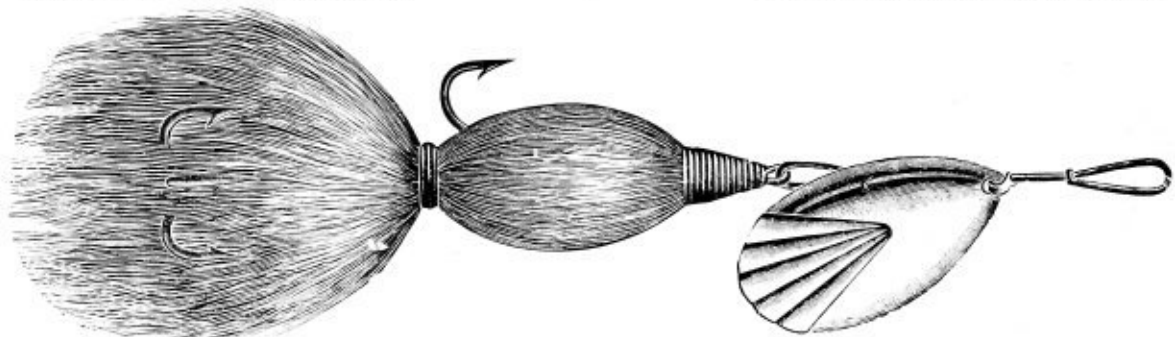

Buck Tail Gang Spoon; concave side blade painted red; convex side nickel plated; sproat and treble hooks, bronzed.

- | | | | |
|-----------------------|-------------|--------|------|
| No. ST112S | —Size spoon | 4½ | 4¾ |
| Size hook | | 1/0 | 2/0 |
| Weight per dozen, oz. | | 9 | 9 |
| Dozen | | \$4.00 | 4.50 |

Packed, one on card; one dozen in box.

TROLLING SPOONS

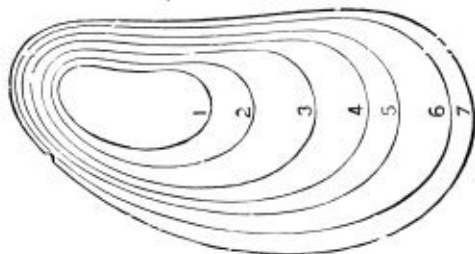
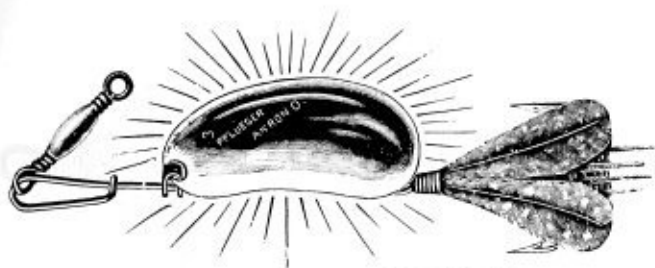

PIKE AND KIDNEY

Pike; tinned; feathered treble hook.

No. ST100S—Sizes	1	2	3	4	5	6	7
Weight per dozen, oz.	2	2	3	4	6	8	10
Dozen	\$0.80	.80	.80	.80	.80	.80	.80

Packed, one dozen in box.

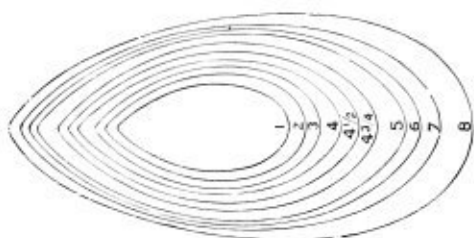
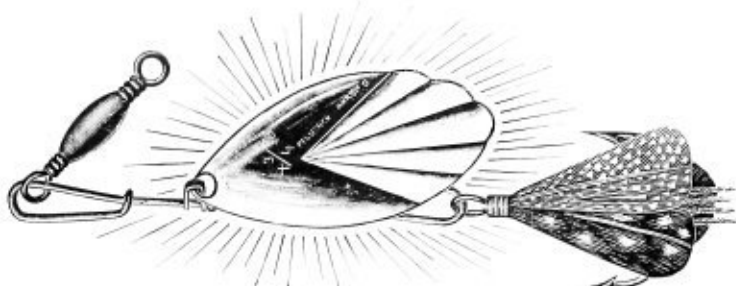

FLUTED

Fluted; nickered; concave side painted red; box swivel; feathered treble hook.

No. ST104S—Sizes	1	2	3	4	4½	4¾	5	6	7	8
Wt. per dozen, oz.	2	2	3	4	4	5	8	9	10	11
Dozen	\$1.30	1.30	1.30	1.30	1.30	1.30	1.30	1.30	1.70	1.70

Packed, one dozen in box.

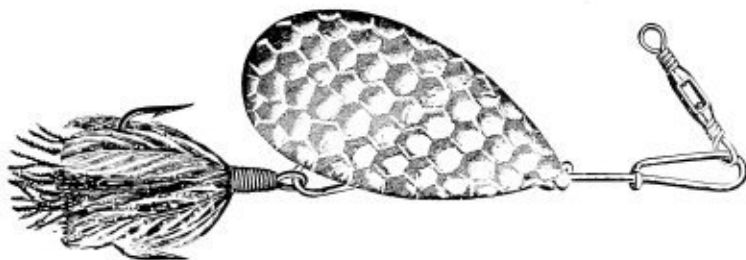
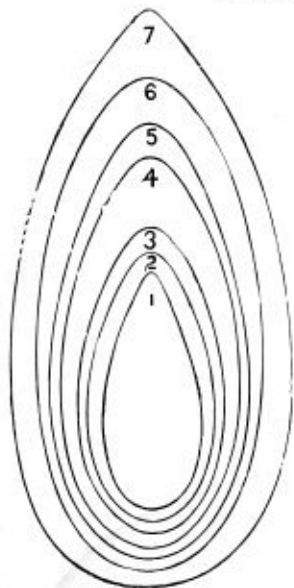

HAMMERED

Nickered; box swivel; feathered treble hook.

No. ST102S—Sizes	1	2	3	4	5	6	7
Weight per dozen, oz.	2	2	3	4	6	8	10
Dozen	\$1.20	1.20	1.20	1.20	1.20	1.20	1.20

Packed, one dozen in box.

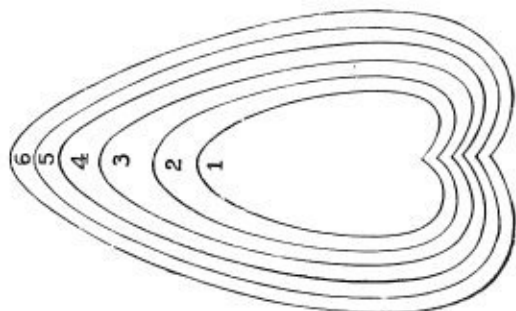
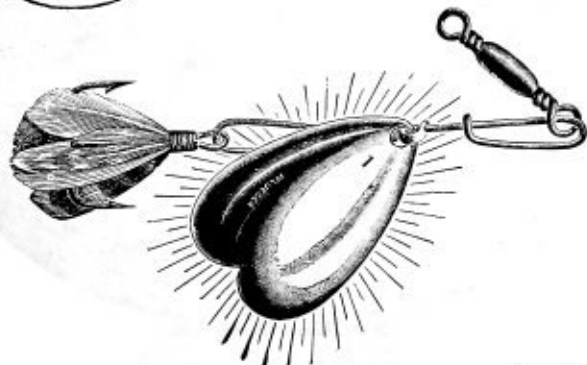

HEART SHAPED LUMINOUS

Nickel plated; luminous on concave side of blade; reversible hinge lug; brass box swivel; feathered treble hook.

No. ST103S—Sizes	1	2	3
Weight per dozen, oz.	2	3	4
Dozen	\$3.00	3.00	3.00

Packed, one dozen in box.

CASTING SUNDRIES

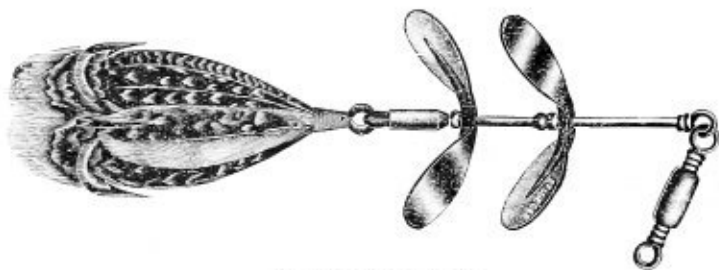

TANDEM SPINNERS

Original design, spinners are mounted with new and improved sliding sleeve hook connection, which permits instant change of feathered bucktail or plain hook.

Luminous polished nickel top of blade; luminous under blade.

No. ST1998—Sizes	2/0	1/0	1	2
Weight per dozen, oz.	8	8	8	8
Dozen	\$6.50	7.00	7.50	8.50

Polished nickel top of blade; red under blade; otherwise same as No. ST1998.

No. ST1999—Sizes	2/0	1/0	1	2
Weight per dozen, oz.	8	8	8	8
Dozen	\$4.00	4.50	5.50	6.00

Packed, one on card; one dozen in box.



No. ST12H

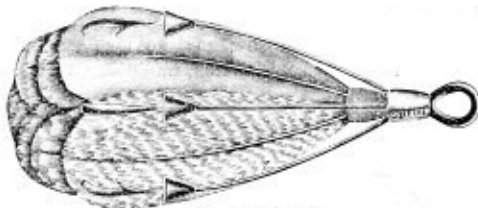

No. ST14BW

TREBLE FEATHERED HOOKS

Bright brazed

No. ST12H—Size	3/0	2/0	1/0	1	2
Weight per gross, lbs.	1	7/8	3/4	1/2	1/2
Dozen	\$0.60	.50	.48	.42	.42

TREBLE FEATHERED WEEDLESS HOOKS

Absolutely weedless; finest quality steel hooks; hand made.

No. ST14BW—Feathered; size 3/0 hook; weight per dozen 9 oz.	Doz.	\$ 4.00
---	------	---------



No. ST488



No. ST489

BUCKTAIL HOOKS

No. ST488—Treble; sizes	1/0	2/0	3/0	4/0	5/0
Weight per dozen, oz.	3 1/2	4 1/2	5	6	7
Dozen	\$1.80	1.80	1.80	2.00	2.00

No. ST489—Single; sizes 2/0, 3/0, 4/0 and 5/0; weight per dozen 4 oz.	Doz.	\$ 1.60
---	------	---------

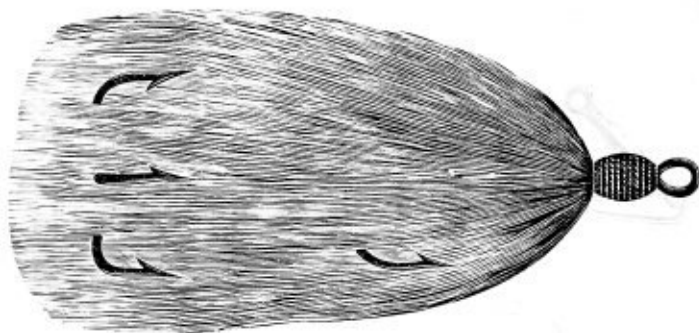

BUCKTAIL GANG

No. ST8MG—White bucktail with red tail, one single and one treble hollow point, bronzed steel hooks; size 3/0; weight per dozen 10 oz.	Doz.	\$ 4.00
--	------	---------

Packed, one in box.

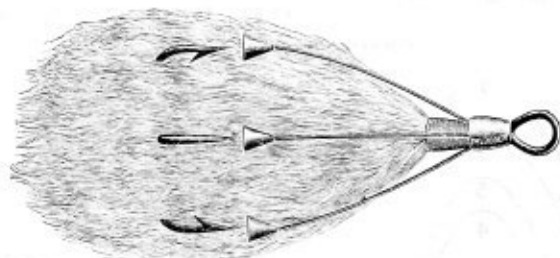

WEEDLESS BUCKTAIL

No. ST14BT—Size 3/0 hook; weight per dozen 9 oz.	Doz.	\$ 4.50
--	------	---------



BUCKTAIL ASSORTMENTS

No. ST352—Bucktail Bait and Weedless Hook Assortment; consists of 21 assorted Bucktail spinners, minnow gangs and weedless hooks; bucktails made of genuine deer tail hair and tied with silk; weight per assortment 3 lbs.	Asst.	\$ 7.04
---	-------	---------

Packed, one assortment on display easel.

ARTIFICIAL TROUT FLIES

ILLUSTRATIONS FULL SIZE

Following species carried in stock, on sizes 4, 6, 8, 10 and 12 hooks, others to order on short notice.



Size 4



Size 6



Size 8



Size 10

Black Gnat	Willow	Jock Scott	McGinty	Brown Ant	Red Ant
Dusty Miller	Bannock Chief	Jungle Cock	Montreal	Cow Dung	Seth Green
Governor	Brown Hackle	King of Waters	Professor	Queen of Waters	Royal Coachman
Gov. Alvord	Grizzly King	Murray Coachman	Parmachenee Belle	Silver Doctor	Shoe Maker
Gray Hackle	Hare's Ear	March Brown	Coachman	White Miller	Yellow Jacket
Captain	Ibis				Western Bee



Standard quality; are made with worsted bodies; dressed on spear point sproat hooks.

No. ST2 ³ / ₄ K—Sizes	4	6	8	10	12
Weight per gross, oz.	6	6	6	6	6
Gross	\$3.60	3.60	3.60	3.60	3.60

Packed, two on perforated card; three connected; one gross in box.

Fine quality; all silk body; dressed on file point Kirby bent hooks.

No. ST2 ¹ / ₄ K—Sizes	4	6	8	10
Weight per gross, oz.	6	6	6	6
Gross	\$6.50	6.50	6.50	6.50

Packed, two on perforated card, three connected; one gross in box.



First quality silk bodies heavily dressed on hollow point sneck hooks with reinforced gut.

No. ST2 ¹ / ₂ —Sizes	4	6	8	10
Weight per gross, oz.	6	6	6	6
Gross	\$11.00	11.00	11.00	11.00

Packed, two on perforated card; three connected; one gross in box.



First quality; divided wing; silk body; dressed on Harrison turn down eye hollow point sproat hooks.

No. STDS—Sizes	4	6	8	10
Weight per gross, lbs.	1	1	1	1
Gross	\$13.00	13.00	13.00	13.00

Packed, one-half dozen on perforated card; one dozen in box; one gross in carton.

Extra fine quality; divided wing; silk bodies; heavily dressed on Harrison's turn-down eye hollow point sneck hooks; highest quality English gut.

No. STES—Sizes	4	6	8	10
Weight per gross, oz.	6	6	6	6
Gross	\$24.00	24.00	24.00	24.00

Packed, on fancy transparent window display envelopes.

BASS FLIES

Following species carried in stock; others to order on short notice. Coachman, Lord Baltimore, Seth Green, Silver Doctor, White Miller, Ibis, Parmachenee Belle, Yellow May, Brown Hackle, Professor, Grizzly King, Dark Montreal and Gray Hackle.

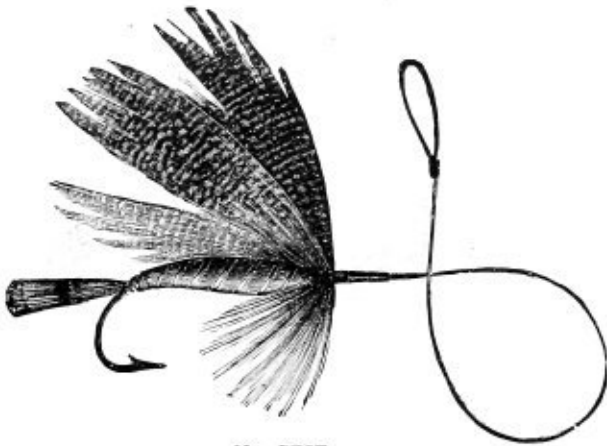

No. ST5F

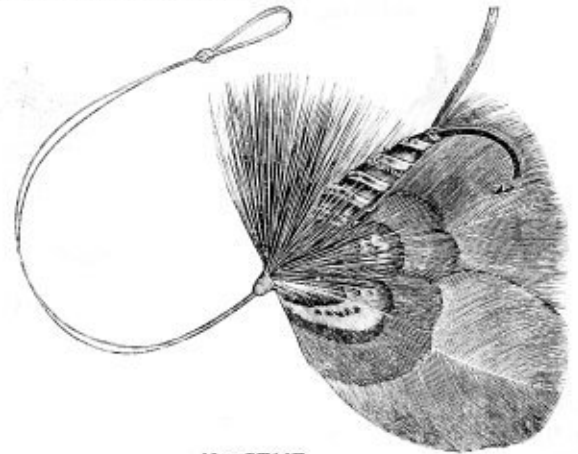

No. ST16F

- No. ST5F—Tied on good quality double gut; worsted body; dressed on spear point sproat hook, size 2/0; weight per dozen 1 oz. \$ 0.60
 No. ST16F—Combination of perfect casting and weedless fly; the quadruple wings and extra heavy hackles are set well over the point of the hook and permit casting into the grassy places, among lily pads and rushes, without any danger of snagging; tied on best hollow point hooks with extra strong double gut snells; weight per dozen 2 oz. 3.00

Packed, one on perforated card; three connected; three dozen in box.

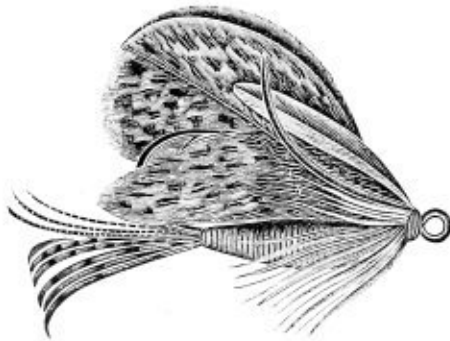

No. ST17F



No. ST18F

- No. ST17F—High grade weighted body bass flies for bait casting; can be used on all casting spoons; weedless waterproof bodies tied on high grade sproat hook; size 4/0; weight per dozen 3 oz. \$ 3.00
 No. ST18F—Same as No. ST17F except not weighted bodies; to be used on light spinners or bass fly rod; tied on high grade sproat hook; sizes 3/0 and 4/0; weight per dozen 2 oz. 3.00

Packed, one on card; three dozen in box.

DESCRIPTION OF TROUT AND BASS FLIES

Black Gnat—Black ostrich body; gold tinsel tag; black hackle legs; lead colored wings.
 Brown Hackle—Peacock body; gold tinsel tag; brown hackle legs.
 Coachman—Peacock body; gold tinsel tag; brown hackle legs; white wing.
 Cow Dung—Olive colored body with brown hackle legs, and brown wing.
 Dusty Miller—Fancy tinsel silvered body; guinea hackle legs; dark turkey wing.
 Governor—Peacock body; red tag; brown furnace hackle legs; dark turkey wing.
 Governor Alvord—Peacock body; red tail; brown hackle legs; lead colored wing.
 Gray Hackle—Peacock body; gold tinsel tag; gray furnace hackle legs.
 Grizzly King—Green silk body wound with gold tinsel; red tail; gray furnace hackle legs; gray mallard wing.
 Hare's Ear—Gray fur body; brown mallard tail; Scotch grouse wing.
 Jock Scott—Yellow silk body; wound with gold cord; ostrich tip; yellow silk tag; golden pheasant crest tail; guinea hackle legs; has a mixed wing of feathers taken from the golden pheasant, jungle cock, brown mallard, wild turkey, yellow and red ibis.
 Jungle Cock—Silver tinsel body; black hackle legs; jungle cock wing.
 March Brown—Dark brown body; ribbed with yellow silk; Scotch grouse tail legs and wing.
 McGinty—Body wound with yellow and black chenille; gold tinsel tag; red and gray mallard tail; brown hackle legs; black wing tipped with white.

Montreal Dark Wing—Red mohair body ribbed with gold cord; red tail; dark red hackle legs; dark turkey wing.
 Professor—Yellow silk body ribbed with gold tinsel; red tail; brown hackle legs; gray mallard wing.
 Queen of Waters—Orange silk body; wound with brown hackle its whole length; brown hackle legs; gray mallard wing.
 Royal Coachman—Peacock body with red band in center; brown hackle legs; white wing.
 Seth Green—Green silk body wound with yellow silk; brown hackle legs; lead colored wing.
 Silver Doctor—Silver tinsel body; ribbed with red silk; red silk tag; blue or guinea hackle legs; or both wings mixed fibres of brown turkey, wood duck bars, yellow and scarlet ibis.
 White Miller—White chenille body; gold tinsel tag; white tail; white hackle legs; white wing.
 Willow—Gray fur body; gold tinsel tag; gray hackle legs; lead colored wing.
 King of Waters—Red silk body wound with brown hackle; brown hackle legs; gray mallard wing.
 Parmachenee Belle—Yellow mohair body; ribbed with gold tinsel; red and white tail; red and white hackle legs; red and white wing.
 Bannock Chief—Peacock body with yellow band in center; red silk tag; brown hackle legs; lead colored wing.
 Red Ant—Red silk body; tipped with peacock brown hackle legs; cinnamon spotted wing.
 Murray Coachman—Peacock body with red band in center; white tail; brown hackle legs; lead colored wing.
 Brown Ant—Brown silk body; tipped with peacock; brown hackle legs; cinnamon spotted wing.

FLY BOOKS

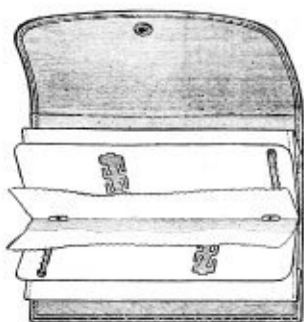

- No. ST60—Pebble cloth cover; canvas lined; vest pocket fly book; one tight pocket in cover; two parchment paper pockets; two parchment paper leaves; carries two dozen flies; two drying pads; snap button lock; size 6x2½ inches; weight per dozen 1½ lbs. \$ 4.70
- No. ST61—Red leather cover; otherwise same as No. ST60; weight per dozen 1½ lbs. 8.00
- No. ST62—Pig roan leather; vest pocket fly book; one tight leather pocket in cover; two parchment paper pockets; two celluloid leaves, carries four dozen flies; two drying pads; snap button lock; size 7x2½ inches; weight per dozen 2½ lbs. 12.00
- Packed, Nos. ST60 and ST61, one-half dozen; No. ST62, one-third dozen in box.

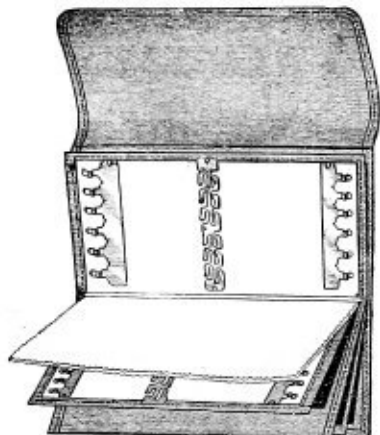

- No. ST70—Walrus grain cloth cover muslin lined; two parchment paper pockets; two parchment paper leaves; carries four dozen flies; two drying pads; snap catch lock; size 6x3½ inches; weight per dozen 2¼ lbs. \$ 6.00
- No. ST72—Pebble grain cloth cover; canvas lined; one tight pocket in cover; two parchment paper pockets; two parchment leaves; carries four dozen flies; two drying pads; snap catch lock; size 7x4 inches; weight per dozen 2¾ lbs. 7.00
- No. ST74—Red leather cover; canvas lined; one tight pocket in cover; two parchment paper pockets; two parchment paper leaves; carries four dozen flies; two drying pads; has the Bray spring attachments; snap catch lock; size 7x4 inches; weight per dozen 3 lbs. 12.00

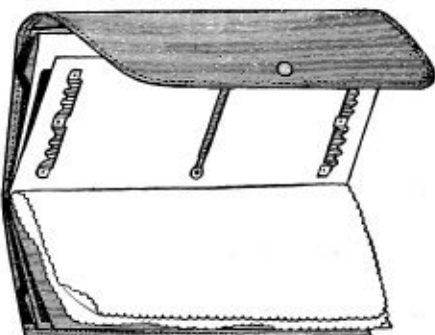

- No. ST95—Seal grain leather cover; leather lined; two tight pockets in cover; two transparent celluloid pockets; two celluloid leaves; carries four dozen flies; two drying pads; has the Bray spring attachments; snap catch lock; size 7x3¼ inches; weight per dozen 6 lbs. \$30.00
- Packed, three dozen in cardboard box.

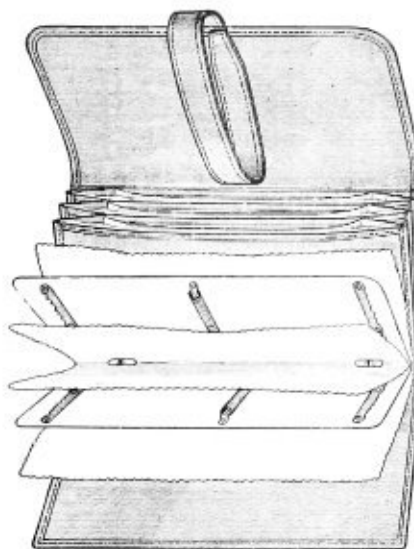

No. ST75

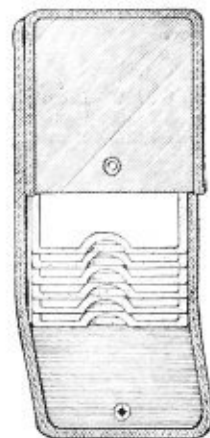

No. ST97

- No. ST76—Bear grain leather cover; keratol lined; two tight pockets in cover; two parchment paper pockets; two parchment paper leaves; carries eight dozen flies; two drying pads; has the Bray spring attachments; snap catch lock; size 7x4 inches; weight per dozen 3¾ lbs. \$14.50
- No. ST75—Red leather cover; canvas lined; combination fly and tackle; four canvas pockets; three small sub-pockets; two parchment paper pockets; two celluloid leaves; carries four dozen flies; two drying pads; strap and buckle lock; size 6½x3½ inches; weight per dozen 4¼ lbs. 20.00
- No. ST97—Imitation alligator keratol envelope; keratol lined; carries three celluloid pockets; others can be added if desired; snap button lock; size 6½x3½ inches; weight per dozen 2 lbs. 7.00
- No. ST96—Celluloid pocket for No. ST97 holder; one side transparent, the other side ivory white celluloid, tipped edges; size 5¼x3 inches; weight per dozen 4 oz. 2.00
- Packed, No. ST76, one-half dozen; No. ST75, one-third dozen; No. ST97, one-quarter dozen; No. ST96, one dozen in box.



COOPER FLY BOOKS

Holds flies in separate holders or envelopes; your flies are always in sight and are protected from moths by the cello camphor tops of the holders; being loose leaf, you can increase or decrease number of holders at will; each book will carry eighteen holders; each holder will carry from two to four dozen flies; size of books, 3¼x7 inches folded; top flap has glove button fastener.

- No. ST11B—Leatherette; complete with three holders; a leather envelope and two drying pads; weight 4 oz. \$16.00
- No. ST21B—Heavy canvas; bound; complete with six holders for flies; one for leaders; two drying pads; weight 7 oz. 32.00
- No. ST22B—Seal grain leather, complete with six holders for flies, one for leaders, and pocket for carrying sundries; two drying pads; weight 8 oz. 56.00
- No. ST23B—Morocco leather; complete with seven holders for flies, and pocket for carrying sundries; two drying pads; weight 8 oz. 72.00
- No. ST25B—Genuine pigskin leather; complete with six holders for flies; one for leaders, and two pockets for carrying sundries; two drying pads; weight 8 oz. 96.00
- Packed, Nos. ST11B to ST25B, one in box.

COOPER HOLDERS

- No. ST26—Extra holders for the above books; weight per dozen 3 oz. \$2.67

SILK WORM GUT

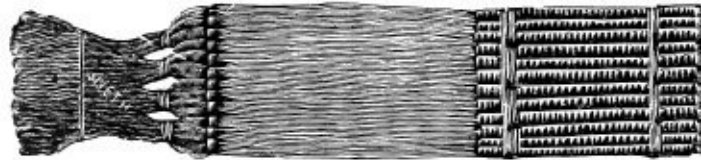

No. ST10G—Regular selecto; 10-inch	Thousand	\$ 7.20
No. ST11G—Padron; second selecto; 11-inch		7.00
No. ST12G—Marana; first selecto; 12-inch		19.00

Average weight per 1000 strands 4 oz.
Packed, 100 in hank; 1000 in bundle.

LEADERS



No. ST21—Superior quality; mist color; 1 yard	SINGLE GUT	Gross	\$ 7.00
No. ST22—2 yards; otherwise same as No. ST21			14.00
No. ST71—Superior quality; mist color with extra loop; 1 yard			7.50
No. ST72—2 yards; otherwise same as No. ST71			15.00
No. ST31—First quality; mist color; 1 yard			14.00
No. ST32—2 yards; otherwise same as No. ST31			28.00
No. ST91—First quality; heavy black color; 1 yard			30.00
No. ST92—First quality; heavy black color; 2 yards			60.00
No. ST101—First quality; heavy mist color; with extra loop; 1 yard			30.00
No. ST102—First quality; heavy mist color; with extra loop; 2 yards			60.00
No. ST103—First quality; heavy mist color; with extra loop; 1½ yards			45.00
No. ST201—Extra quality; mist color; 1 yard			36.00
No. ST202—Extra quality; mist color; 2 yards			72.00

DOUBLE GUT

No. ST221—Superior quality; mist color; 1 yard		Gross	\$14.00
No. ST222—2 yards; otherwise same as No. ST221			28.00
No. ST331—First quality; mist color; 1 yard			28.00
No. ST332—2 yards; otherwise same as No. ST331			56.00

TREBLE TWISTED GUT

No. ST81—First quality; mist color; 1 yard		Gross	\$30.00
No. ST82—2 yards; otherwise same as No. ST81			60.00

Average weight per gross 1¾ lbs.
Packed, one on card; one dozen in box.

PIANO WIRE

No. ST111—Piano wire; rust-proof; swivel on one end, loop on other; length 18 inches; weight per gross 1 lb		Gross	\$ 8.50
---	--	-------	---------

COOPER PATENT SNAP AND LEADER



No. ST207—Brass box swivels; blued steel wire snap; 5-inch bronzed wire leader; weight per gross 12 oz		Gross	\$18.00
--	--	-------	---------

Packed, one gross in box.

FISHING FLOATS

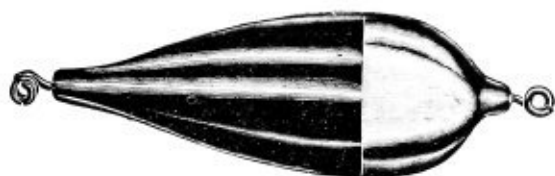

Egg shaped; wooden; adjustable; spring tempered wire spirals; painted and varnished.

No. ST25F—Size, inches.....	1½	2	2½
Weight per gross, lbs.....	4¼	5¾	8
Gross	\$2.70	3.40	4.20

Packed, one-quarter gross in box.

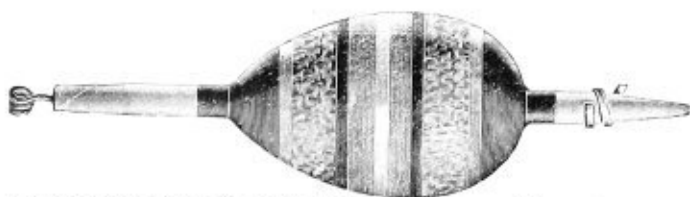

Egg shaped; unpainted cork; varnished; fancy stripe spiral top.

No. ST33F—Size, inches.....	1½	2	2¼	2½
Weight per gross, lbs.....	4¼	5	6	7½
Gross	\$10.00	12.00	15.00	18.00

Packed, one-twelfth gross in box.

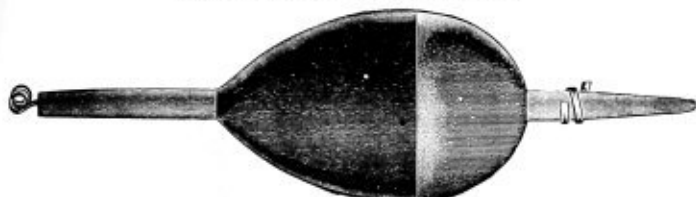

Egg shaped; wood; spiral top; painted and varnished.

No. ST27F—Size, inches.....	1¾	2	2¼	2½
Weight per gross, lbs.....	5½	6	6½	7
Gross	\$3.30	3.60	4.50	5.60

Packed, one-twelfth gross in box.



Barrel shaped; wooden; adjustable; spring tempered wire spirals; painted and varnished.

No. ST28F—Size, inches.....	2	2½	3	3½
Weight per gross, lbs.....	2½	3	4¼	5
Gross	\$2.50	3.50	4.00	4.50

Packed, one-quarter gross in box.

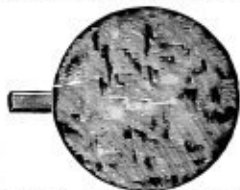

Ball; unpainted cork; with wooden stick.

No. ST24F—Size, inches.....	1½	1¾	1¾
Weight per gross, lbs.....	1½	1¾	2
Gross	\$4.50	5.50	6.00

Packed, one-twelfth gross in box.



Barrel shaped; cork; spiral top; painted and varnished.

No. ST29F—Size, inches.....	1½	1¾	2	2¼	2½	2¾	3
Weight per gross, lbs.....	2¼	2½	2½	2½	3	4¼	4¼
Gross	\$5.60	6.50	7.20	8.00	9.00	10.00	11.00

Packed, one-twelfth gross in box.

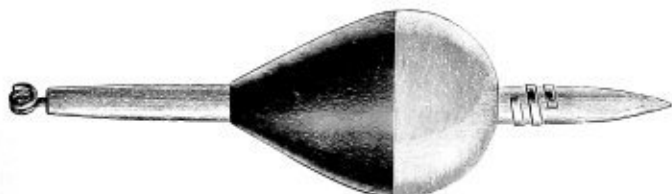

Egg shaped; cork; spiral top; painted and varnished.

No. ST26F—Size, inches.....	1¼	1¾	2	2¼	2½	2¾	3	3½	4
Wt. per gro., lbs.....	4	5	5½	6	7½	8	11	12	14
Gross	\$5.20	6.70	8.50	10.50	12.00	16.00	20.00	36.00	54.00



Barrel shaped; cork; painted; fancy stripe spiral top.

No. ST32F—Size, inches.....	1¾	2	2½	3	3½
Weight per gross, lbs.....	2½	2½	4¼	4½	4½
Gross	\$10.00	13.00	16.00	19.00	

Packed, one-twelfth gross in box.



Egg shaped; solid cork; patented brass, spiral line fasteners; enameled red and green.

No. ST211F—Size, inches.....	1½	1¾	2	2½	3
Weight per gross, lbs.....	4¼	5	5½	7½	11¼
Gross	\$10.00	10.80	12.50	19.00	26.40

Packed, one-twelfth gross in box.



Barrel shaped; solid cork; patented brass spiral line fasteners; enameled red and green.

No. ST217F—Size, inches.....	1¾	2	2¼	2½	3
Weight per gross, lbs.....	2½	2½	2½	3	4¼
Gross	\$10.80	11.40	12.50	14.50	19.00

Packed, one-twelfth gross in box.

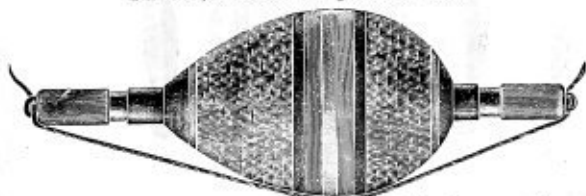

Egg shaped; red fields; hollow cork; varnished; fancy stripe; patent adjustable spring cap ends for line.

No. ST31F—Size, inches.....	2	2½	3
Weight per gross, lbs.....	5	7	10
Gross	\$18.00	24.00	30.00

Packed, one-twelfth gross in box.

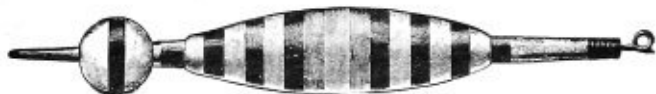

Zebra; barrel shaped; cork; wooden pilot; stick top; painted and varnished.

No. ST30F—Size, inches.....	2	2½	3	3½
Weight per gross, lbs.....	2¾	3	4	5½
Gross	\$14.40	16.00	20.00	24.00

Packed, one-twelfth gross in box.

LEAD SINKERS

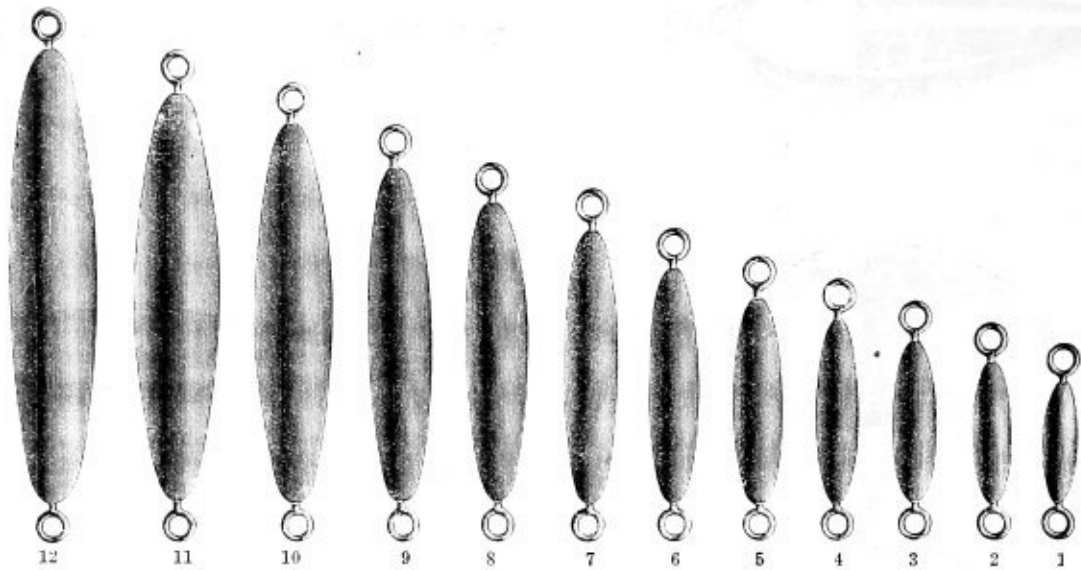

BRASS RINGED

No. ST621S—Sizes	12	11	10	9	8	7	6	5	4	3	2	1
Weight per gross, lbs.	20	18	16½	13	8¾	7	5	3¾	2¾	1¾	1⅞	1½
Gross	\$8.00	6.50	5.50	4.50	3.60	2.00	1.40	1.20	1.10	.90	.80	.70

Packed, Nos. 12 to 3, one-half gross in box; No. 2, one-third gross in box; No. 1, one-quarter gross in box.

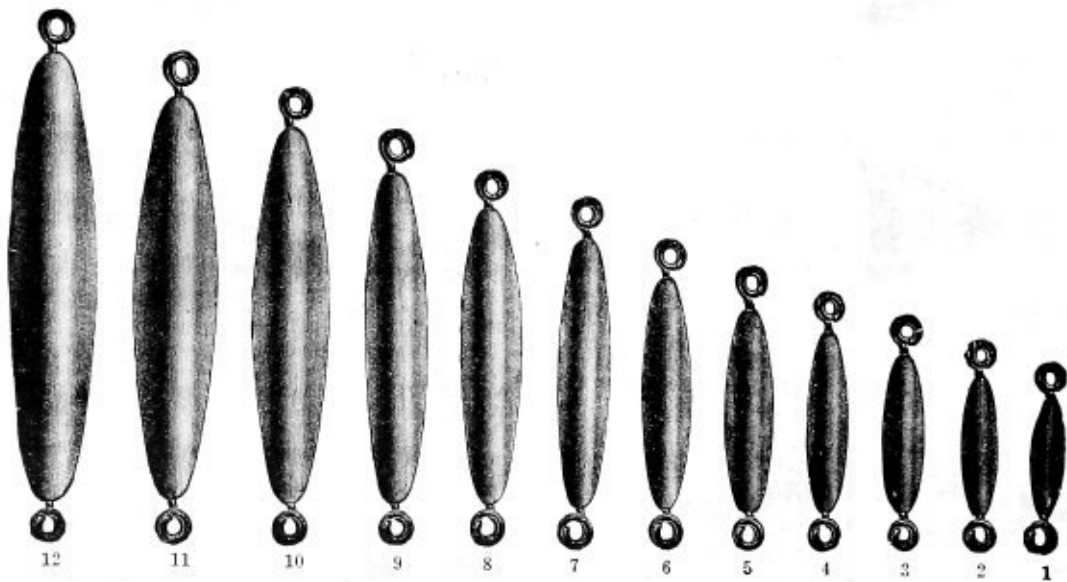

ADJUSTABLE RINGED

No. ST622S—Sizes	12	11	10	9	8	7	6	5	4	3	2	1
Weight per gross, lbs.	18	16½	13	8¾	7	5	3¾	2¾	1¾	1⅞	1½	5/8
Gross	\$4.80	4.00	3.40	2.40	1.80	1.60	1.30	1.20	.90	.80	.70	.60

Packed, Nos. 12 and 11, one-quarter gross in box; Nos. 10 to 8, one-half gross in box; others, one gross in box.

SINKERS



RANGELY PATTERN

No. ST617—Sizes	1	2	3	4	5	6	7	8	9	10
Weight per gross, lbs.	3/4	1 1/4	1 3/4	2	2 1/4	2 3/4	3 1/4	4 1/4	5 1/4	6 1/4
Gross	\$0.50	.70	.90	1.00	1.10	1.30	1.70	2.00	2.30	2.60

Packed, Nos. 1 to 5, one gross in box; others, one-half gross in box.

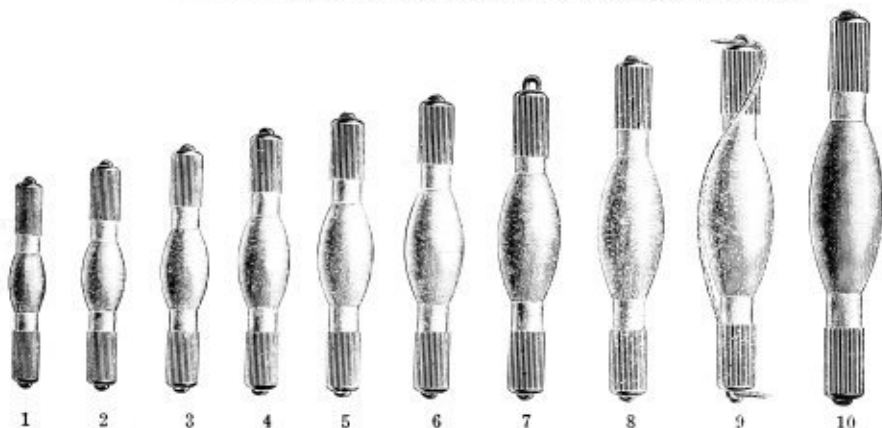

REDFIELD PATENT ADJUSTABLE SPRING CAP

These sinkers can be adjusted instantly as follows: pull little brass cap down, insert line under the hook in top, then allow brass cap to slide up.

No. ST623—Sizes	1	2	3	4	5	6	7	8	9	10
Weight per gross, lbs.	1	1 1/4	1 3/4	2	2 1/4	2 3/4	3 1/4	4 1/4	5 1/4	6 1/4
Gross	\$3.00	4.00	4.70	5.30	6.00	6.70	7.50	8.50	9.30	10.00

Packed, Nos. 1 to 6, one gross in box; 7 to 10, one-half gross in box.

SWIVELS



No. ST212—Brass; assorted sizes, 2 small, 4 medium, and 6 large; two dozen each; weight per gross 6 oz.	Gross	\$ 4.00
---	-------	---------

Packed, one-half gross in box.



BRASS BOX BEST ENGLISH

No. ST152B—Sizes	1 to 7	1/0	2/0	3/0
Average weight per gross, lbs.	%	1	1 1/2	1 3/4
Gross	\$2.40	4.00	5.20	7.70

Packed, one-quarter gross in box.



No. ST619

SPLIT SHOT
In wood boxes.

No. ST618—Size BB; weight per gross boxes 4 3/4 lbs.	Gross Boxes	\$ 3.00
No. ST619—Size 7 buck; weight per gross boxes 12 lbs.	Gross Boxes	4.50



JAMISON NON-KINKING

This sinker absolutely prevents the line from twisting, either in casting or trolling; the snaps are tested to 60 lbs.

No. ST620—Non-kinking sinker; weight per dozen 4 oz.	Doz.	\$ 0.80
--	------	---------

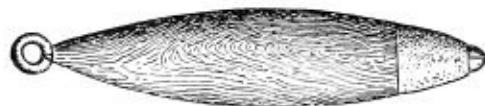

TOURNAMENT WEIGHTS

For practice casting or tournament work; fine for beginners to learn to cast with.

No. ST1209—Casting weight; weight per dozen 6 oz.	Doz.	\$ 3.00
---	------	---------



COOPER PATENT SNAP

Brass box swivels; blued steel wire snap.

No. ST216—Sizes	1	3	5
Weight per gross, oz.	12	9	7
Gross	\$8.00	8.00	8.00

SNAPS AND RINGS



No. ST205—Set line snaps and rings; solid brass; weight per gross 8 oz.	Gross	\$ 2.00
---	-------	---------

Packed, one gross in box.

CONNECTING LINK ASSORTMENTS



No. ST214—Made of German silver; simple, strong and light; put up six dozen in box, with three compartments; two dozen of each size; small, medium and large; weight per gross 6 oz.	Gross	\$ 2.00
--	-------	---------

STEEL SPLIT RINGS



No. ST210—Size, inches $\frac{3}{16}$ to $\frac{1}{2}$ $\frac{1}{4}$ to $\frac{1}{2}$
 Average weight per gross, oz. $3\frac{1}{2}$ $2\frac{1}{2}$
 Gross \$0.90 .90

FISH STRINGERS



No. ST805S—Braided, mottled cotton line; weight per dozen $\frac{5}{8}$ lb. \$ 0.80

Packed, one on card; six dozen in box.

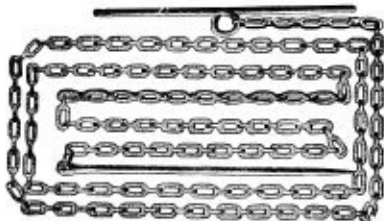

No. ST804S—Nickel plated brass, 4-foot detachable chain; weight per dozen $1\frac{1}{4}$ lbs. \$ 2.20

Packed, one dozen in box.

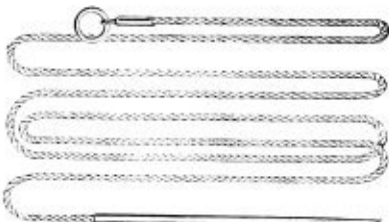

No. ST807S—Braided 4-foot cord; brass needle and ring; weight per dozen $1\frac{1}{4}$ lbs. \$ 2.00

Packed, one dozen in box.

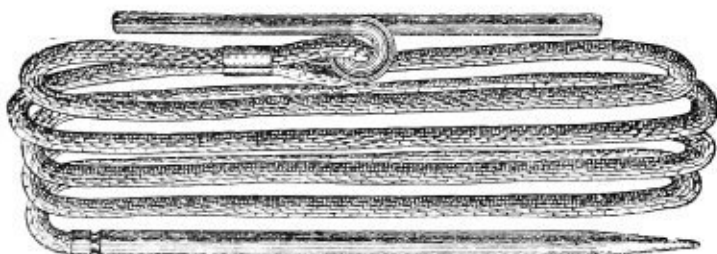

No. ST809S—Braided 6-foot cord with brass needle and detachable brass bar; weight per dozen $1\frac{1}{2}$ lbs. \$ 2.50

Packed, one dozen in box.

FISH STRINGERS

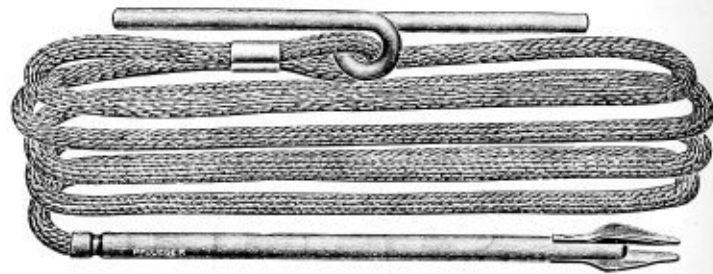

No. ST808S—Braided 6-foot cord with disgorger instead of needle and detachable brass bar; weight per dozen 2 lbs. \$ 3.00

Packed, one dozen in box.

**ROD MOUNTINGS
SNAKE RING GUIDES**



Gun metal finish.

No. ST1524—Sizes	Small	Medium	Large
Weight per gross, oz.	1	2	3
Dozen	1	2	2
	\$0.40	.40	.40

PLAIN BRASS TIE GUIDES



3/0 2/0 1/0 1 2 3 4

Sizes 3/0 small, to 4 large.

No. ST1519—Sizes	3/0	2/0	1/0	1	2	3	4
Weight per gross, oz.	2	3	4	5	6	7	8
Gross	\$2.50	2.50	2.50	2.50	2.50	2.50	2.50

TRUMPET TIE GUIDES

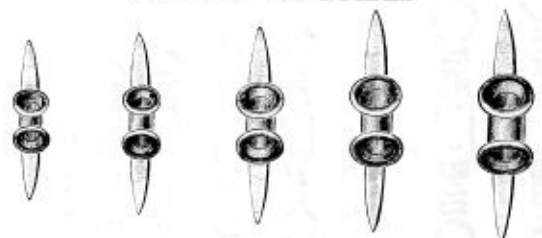

1 2 3 4 5
 German silver; anti-friction; trumpet guides.

No. ST1509—Sizes	1	2	3	4	5
Weight per gross, oz.	4	5	6	7	8
Dozen	\$1.20	1.20	1.20	1.20	1.20

ROD MOUNTINGS

CASTING GUIDES

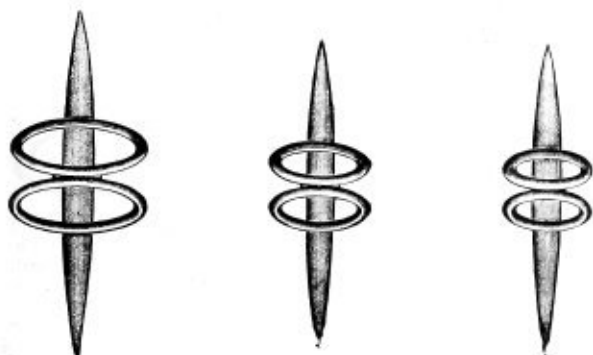

German silver; two-ring casting guides.

No. ST1548—Sizes	1	2	3
Weight per gross, oz.	16	20	24
Dozen	\$1.20	1.20	1.20

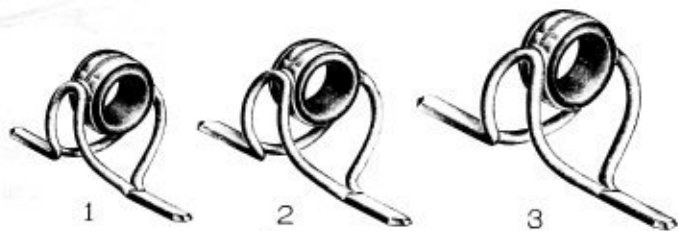

Imitation agate casting guides; good quality.

No. ST1521—Sizes	1	2	3
Weight per gross, oz.	5½	6	7
Dozen	\$7.50	7.50	7.50

Agate casting guides; first quality.

No. ST1547—Sizes	1	2	3
Weight per gross, oz.	12	16	18
Dozen	\$15.00	15.00	15.00

ROD TIPS



Stirrup tips; German silver.

No. ST1534—Sizes	2/0	0	1	2
Weight per gross, oz.	1	1¼	1½	1¾
Dozen	\$1.30	1.30	1.30	1.30



Single ring; German silver.

No. ST1550—Sizes	0	1	2
Weight per gross, oz.	2	2	2
Gross	\$4.00	4.00	4.00

Three-ring; German silver.

No. ST1560—Sizes	0	1	2	3
Weight per gross, oz.	8	10	13	18
Gross	\$7.00	7.00	7.00	7.00

ROD TIPS



Tubes, brass

No. ST1570—Sizes	0	1	2	3	4	5
Weight per gross, oz.	¾	1½	1	1½	1½	2
Gross	\$6.00	6.00	6.00	6.00	6.00	6.00

CASTING AND FLY TIPS



Imitation agate offset tops; good quality.

No. ST1522—Sizes	Small 2/0	Medium 1/0	Large 1
Weight per gross, oz.	8	9	10
Dozen	\$7.50	7.50	7.50

Genuine agate offset tops, braced; first quality.

No. ST1585—Sizes	Small 2/0	Medium 1/0	Large 1
Weight per gross, oz.	12	18	24
Dozen	\$12.00	12.00	12.00



Genuine agate offset tips; German silver mounted.

No. ST1532—Sizes	2/0	0	1
Weight per gross, oz.	12	18	24
Dozen	\$18.00	18.00	18.00

EMERGENCY TIPS



No. ST33—Emergency tips, for steel rods; takes the place of a broken tip or can be used to shorten a rod; weight per dozen 4 oz.	Doz. \$ 3.00
--	--------------

REDUCING FERRULES

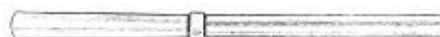

No. ST34F—For steel rods; can be used to repair a break or shorten a rod; weight per dozen 6 oz.	Doz. \$11.34
--	--------------

FISHING SUNDRIES

REEL SEATS



No. ST2S—Bower's; nickel plated; can be applied to any reel; no cutting or fitting required; size 6½x¾-inch; weight per dozen 1¼ lbs. \$ 3.60
 Packed, one dozen in box.

FISH SCALERS



No. ST728—Double steel blade serrated on both edges; riveted to cast iron handle; blades set at angle of 45 degrees; entire instrument heavily tinned to prevent rust; full length 6¾ inches; length of blades 2 inches and 3 inches respectively; width of blades ¾-inch; will remove scales and fins in half the time required when knife is used; weight per dozen 3¾ lbs. \$ 3.00
 Packed, one-sixth dozen in cardboard box.

ROD VARNISH



FERRULE CEMENT



No. ST254—Rod varnish; this varnish has been especially prepared for fishing rods; it combines water-proof and elastic qualities in the highest degree, and has been highly commended by anglers who have used it; weight per dozen 3 lbs. \$ 3.00
 No. ST255—Ferrule cement; this compound is not affected by sun heat or water; unlike other cements, it makes a thoroughly dependable joint which can be loosened by heating, without injury to the ferrule or rod; weight per dozen 1 lb. 3.50

ROD WINDING SILK



No. ST256—Finest quality silk for winding rods; red, orange, green or black; weight per dozen 8 oz. \$ 1.80
 Packed, one dozen assorted colors in box.

FISH SCALES



Extra fine; American, round nickel case.
 No. 10—Capacity 10 pounds by 4 ounces; length 4¼ inches; weight per dozen 8 oz. \$ 6.00
 No. 20—Capacity 20 pounds by 4 ounces; length 5½ inches; weight per dozen 1 lb. 8.00

ROD COVERS



Canvas, with strap and buckle.
 No. ST119—Length 42 inches; weight per dozen 3 lbs. \$11.50



Russet leather, telescopic, for two rods.
 No. ST117—Diameter 2¾ inches, with strap and buckle; weight per dozen 18 lbs. \$66.00

GAFF HOOKS



No. ST6GH—Fine quality; nickel plated; ebonized handle; 7-inch joints; entire length 21 inches; weight per dozen 6 lbs. \$12.00
 Packed, one in box.

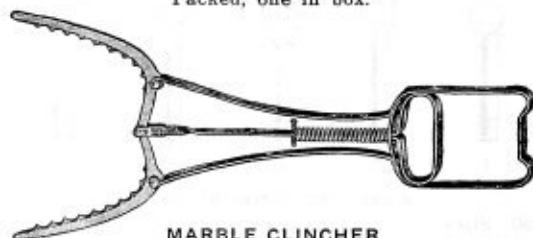

No. ST321—Gaff is 18 inches long; 7½ inches between points; can be locked with points together; made of polished steel, heavily nickled; very strong and durable; weight per dozen 8¼ lbs. \$16.00
 Packed, one-quarter dozen in box.

FISHING SUNDRIES

SPEARS



FROG

No. ST30S—3-prong; brass socket and point guard; weight per dozen 2½ lbs. \$ 2.00
Packed, one dozen in box.



FISH

No. ST10S—3-prong; 2¼-inch socket; weight per dozen 3 lbs. .. \$ 3.60
Packed, one dozen in box.

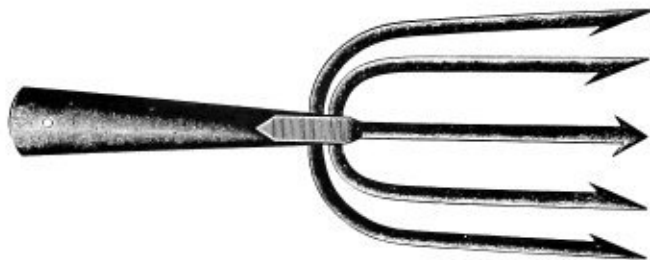

FISH

No. ST1S—3-prong; 2¼-inch tanged; weight per dozen 2 lbs. ... \$ 3.50
No. ST2S—5-prong; 4-inch tanged; weight per dozen 4½ lbs. ... 4.00
No. ST20S—5-prong; 4-inch socket; weight per dozen 3¾ lbs. ... 5.50
No. ST4S—5-prong; 4½-inch socket; weight per dozen 5 lbs. ... 7.00
No. ST5S—5-prong; 5-inch socket; weight per dozen 6 lbs. 8.50
Packed, one dozen in box.

DISGORGERS

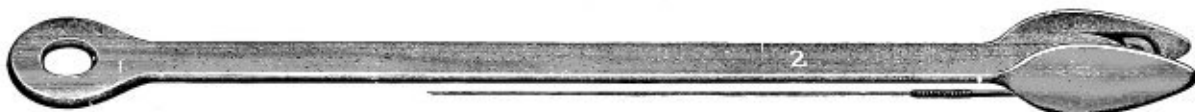

No. ST2D—Malleable iron; single; nickel plated; length 6½ inches; weight per dozen ¾ lb. \$ 1.20
Packed, one dozen in box.



No. ST1D—Fords'; double; brass; nickel plated; length 7¼ inches; weight per dozen 1 lb. \$ 2.20
Packed, one dozen in box.



No. ST10½

OAR LOCKS

No. ST10½—Socket; plain malleable; 2-inch; weight per pair 20 oz. \$ 0.24
No. ST12½—North River; galvanized; malleable; 2-inch; weight per pair 20 oz.40
No. ST13½—Plain malleable; otherwise same as No. 12½; weight per pair 20 oz.30



Nos. ST12½ and ST13½

BOAT OARS



First quality; selected straight grain; straight blade ash.

No. ST98—Length, feet	6	6½	7	7½	8	8½
Weight per pair, lbs.	7	7½	9	10	11	11½
Pair	\$2.16	2.34	2.52	2.70	2.88	3.06

Copper tipped; first quality; straight blade, ash.

No. ST99—Length, feet	7	7½	8
Weight per pair, lbs.	8½	9	10
Pair	\$2.80	3.00	3.20

FLY AND LEADER BOXES



No. **ST12LB**—Round; aluminum satin finish; size $3\frac{3}{4} \times 1\frac{1}{2}$ inch; hinged cover; two heavy felt drying pads; weight per dozen $1\frac{1}{4}$ lbs. \$ 3.20
 Packed, one dozen in box.

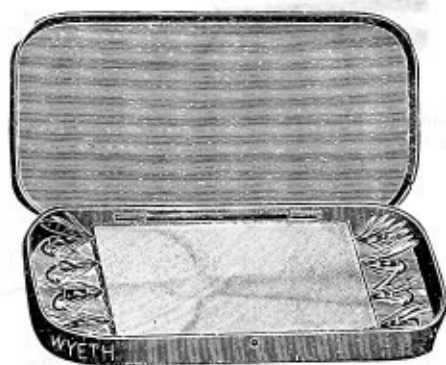

No. **ST11FB**—Oblong; aluminum; polished finish; size $6\frac{1}{4} \times 3\frac{3}{4} \times \frac{1}{2}$ inch; hinged cover aluminum combs to keep flies in position; two heavy felt drying pads; weight per dozen 2 lbs. \$ 8.00
 Packed, one dozen in box.

BAIT BOXES



No. **ST3BB**—Crescent shape; tin; assorted colors; ventilated hinged cover; two loops on back to fasten on to belt around the waist; weight per dozen $2\frac{3}{4}$ lbs. \$ 2.00
 Packed, one dozen in box.



No. **ST2BB**—Trout basket shape; tin; assorted colors; size $3\frac{1}{2} \times 2\frac{1}{2} \times 2$ inches; ventilated hinged cover; safety pin on back to fasten to coat; weight per dozen $1\frac{3}{4}$ lbs. \$ 1.60
 Packed, one dozen in box.

MINNOW TRAPS

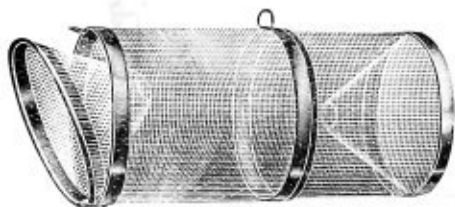

Trap Extended



Trap Telescoped

No. **ST155**—Lucas Telescope; for minnows, eels and crawfish; made of $\frac{1}{8}$ -inch mesh galvanized wire cloth; end and center rims of galvanized iron; extends from $9\frac{1}{2}$ to 16 inches; diameter $7\frac{1}{2}$ inches; hinged door in end full size of trap; weight per dozen 24 lbs. \$14.40
 Packed, one-half dozen in box.

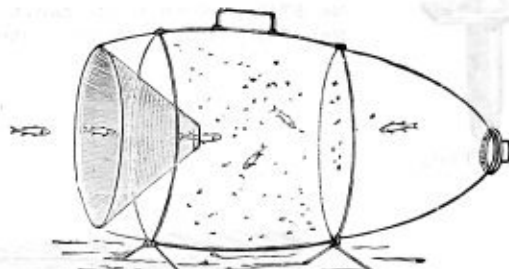

No. **ST49**—Orvis; made of heavy flint glass; handle and legs of galvanized metal; length 12 inches; diameter 8 inches; weight 10 lbs. \$42.00
 Packed, one in hinged wood box.

Directions

Place a handful of cracker crumbs inside the trap; attach a cord to the handle and lower trap where minnows frequent; when lowering into deep water fasten end of cord to a float so trap can be readily regained.

TACKLE BOXES



No. STP



No. ST01B



No. ST02B



Nos. ST03B and ST04B

- No. STP—Pocket; size 7½x4½x1¾ inches; four compartments; green enameled with gold stripes; weight per dozen 8 lbs. Doz. \$ 6.50
 No. ST01B—Size 8¼x4¼x3 inches; four compartments; with hasp; brown japanned with gold stripes; weight per dozen 11 lbs. Doz. 7.50
 No. ST02B—Size 10½x5½x4 inches; three compartments in box; five spaces in tray with hasp; golden brown japanned with neat gold stripes; weight per dozen 20 lbs. Doz. 11.00
 No. ST03B—Size 12¼x6½x5½ inches; two compartments in box; two trays; one with six, the other with three compartments; golden brown japanned with gold stripes; weight per dozen 26 lbs. Doz. 16.00
 No. ST04B—Size 12¼x6½x5½ inches; two compartments in box; two trays; one with six, the other with three compartments; extra heavy tin plate with hasp and improved locking device japanned in rich green enamel ornamented with gold stripes; weight per dozen 30 lbs. Doz. 20.50



No. ST07B



No. ST05B



No. ST06B

- No. ST07B—Seamless steel box; size 11½x5½x2½ inches; divided into two halves, with close fitting lid between; upper half is one large compartment; lower half has seven compartments, one for reel, five for hooks, one for snelled hooks; improved lock; finished in black; weight per dozen 30 lbs. Doz. \$18.00
 No. ST05B—Size 11½x8x4¼ inches; five compartments in box; one for reels and four for snell hooks with three extra trays; one plain tray 7¼x4¼ inches; one tray of the same dimensions with three compartments; one tray with six spaces for artificial minnows and three small spaces for loose hooks, sinkers, etc. This box is complete in every detail; weight per dozen 45 lbs. Doz. 31.50
 No. ST06B—Size 12½x8x4½ inches; six compartments in box; two trays; one with six compartments and hinged cover; other tray with two compartments; finished inside in deep blue lacquer; outside with jet black enamel; decorated with red and gold stripes; nickel plated Yale lock and heavy leather handle; weight per dozen 60 lbs. Doz. 95.00

MINNOW BUCKETS



Heavy tin japanned; in assorted colors; fancy striped; with wire bail and black hardwood handle.

	Perforated insert; non-floating; enameled.			
Nos.	ST6MB	ST8MB	ST10MB	ST12MB
Size, quarts	6	8	10	12
Wt. doz., lbs.	21	22	27	32
Dozen	\$11.00	12.00	13.00	15.00

	Galvanized; floating wire insert; enameled.		
Nos.	ST108MB	ST110MB	ST112MB
Size, quarts	8	10	12
Wt. per doz., lbs.	40	48	56
Dozen	\$16.50	18.50	22.00

	Oval galvanized; floating wire insert; enameled.	
Nos.	ST525MB	ST535MB
Size, quarts	8	10
Weight per dozen, lbs.	30	36
Dozen	\$22.00	24.00

FISH BASKETS



No. STBB

FOLDING CANVAS

Doz.

No. STBB—Heavy brown duck; rattan and japanned steel stiffening braces; top buttons on to body; cotton web and russet leather shoulder strap to buckle; capacity 20 lbs.; 12x9x5½ inches; weight per dozen 10 lbs. \$15.00
Packed, one in box.



Nos. ST1B to ST4B



Nos. ST40B to ST60B

WILLOW

Finest quality double woven French willow; round; with plain fasteners.

Nos.	ST1B	ST2B	ST3B	ST4B
Capacity, lbs.	15	18	22	25
Size, inches	8x4x16	8x5x12	9x5x12	10x6x13
Weight per dozen, lbs.	10	11	12	13
Dozen	\$23.70	28.00	33.00	39.20

Finest quality double woven French willow; round; with patent fastener, and leather hinge.

Nos.	ST40B	ST50B	ST60B
Capacity, lbs.	25	30	35
Size, inches	12x10x6	14x10x6	15x12x6½
Weight per dozen, lbs.	18	21	27
Dozen	\$41.00	46.00	53.00

BASKET BINDINGS

No. STBB70—Russet leather; complete for above baskets; put Each on at our own factory \$ 6.50

FISH BASKET SLINGS



No. ST55S—Plain strap; 2-inch web center; 48 inches long; Doz. leather ends; weight per dozen 2 lbs. \$ 4.00
Packed, one dozen in box.

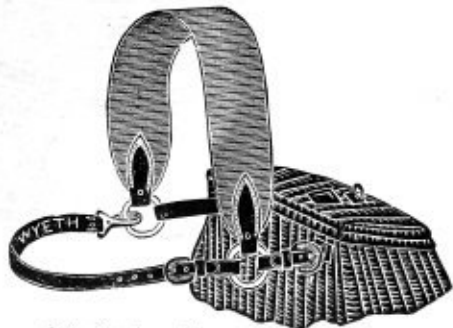

Cut showing sling attached to basket

No. ST48S—Sling; 2-inch webbing; leather straps, with snap Doz. for adjusting; weight per dozen 3½ lbs. \$ 6.00
Packed, one dozen in box.

AQUARIUM DIP NETS



No. ST16DN—Wire handle; diameter 4 inches; 4 inches deep; Doz. ¼-inch mesh; weight per dozen 1½ lbs. \$ 2.10

COLLAPSIBLE LANDING NETS



No. ST11LN—12-inch handle; ring 10½x11 inches; complete Doz. with 20-inch tan color landing net; weight 4 oz. \$18.00
Packed, one in partitioned cloth bag.

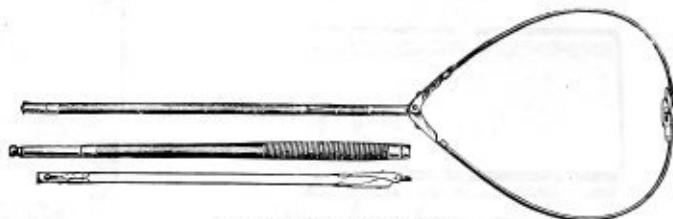

With detachable handle.

No. ST12LN—Entire length 5 feet 3 inches; 2-joint; 4-foot wood Doz. handle; nickel plated trimmings and ferrules; 15x14-inch tempered steel ring coated with best black rubber; enamel; complete with 20-inch tan color landing net; weight per dozen 12 lbs. \$30.00



No. ST18LN—Entire length 5 feet 3 inches; 2-joint; 4-foot wood Doz. handle; nickel plated brass trimmings; 15-inch ring; made of best tempered steel; can be expanded in an instant; complete with 24-inch dip net; weight per dozen 14 lbs. \$36.00
Packed, one in partitioned cloth bag.

LANDING NETS AND FRAMES

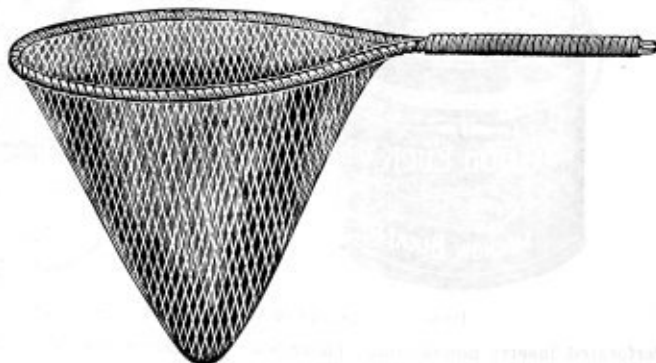

No. ST14LN—Large rattan frame and handle; with 18-inch cot- Doz. ton landing net; bow 10x11 inches; weight per dozen 1½ lbs. \$ 7.50

LANDING NETS AND FRAMES



No. ST15LN—Rainbow; rattan frame 9x11½ inches; enameled wood handle; 18-inch tan landing net; pure gum rubber shoulder sling; weight per dozen 3 lbs. Doz. \$12.00

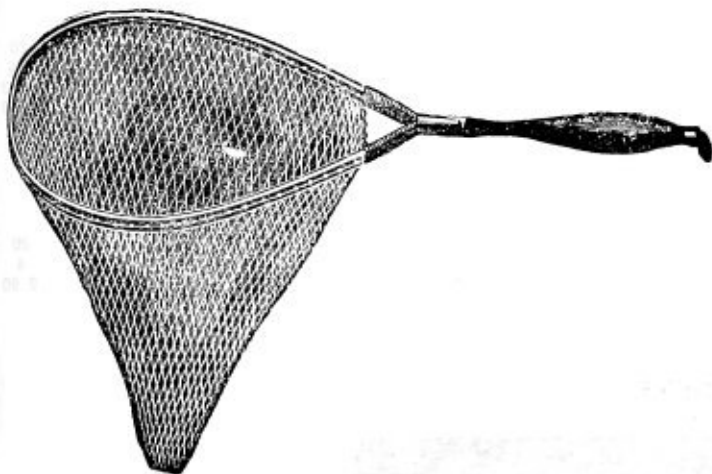

No. ST19LN—Wood frame 10¼x16½ inches; 10-inch detachable wood handle; 20-inch cotton landing net; weight per dozen 7½ lbs. Doz. \$14.00

No. ST20LN—Wood frame 10¼x16½ inches; 20-inch detachable wood handle; 20-inch cotton dip net; weight per dozen 8 lbs. Doz. 16.00



No. ST51J—Complete with 12-inch ring; 14-inch dip net; 3½-foot handle; weight per dozen 22 lbs. Doz. \$ 7.50
 No. ST51—Complete with 16-inch rust-proof ring; 20-inch cotton dip net; 4-foot, two-piece handle; weight per dozen 24 lbs. Doz. 18.00

LANDING NETS

MINNOW DIP NETS

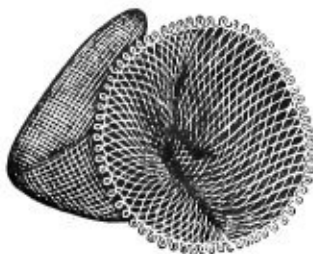

No. ST17LN



No. ST11DN

Best quality cotton twine ¾ mesh; no rings or handle.

No. ST17LN—Length, inches	20	24	30
Weight per dozen, oz.	10	13	19
Dozen	\$2.40	2.90	3.60

Best quality cotton twine ¾ mesh at top; ⅝ at bottom.

No. ST11DN—Length, inches	16	18	20	24	30
Weight per dozen, oz.	6	9	10	13	19
Dozen	\$4.00	5.20	6.30	7.70	10.50

FISH BAGS

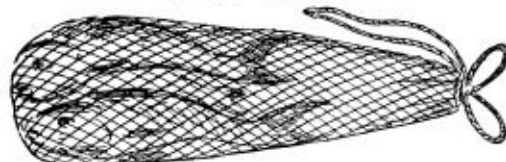

No. ST2FB—Plain bag to tie at top; 1-inch mesh; two feet long; No. 16 thread; weight per dozen 1½ lbs. Doz. \$ 2.80

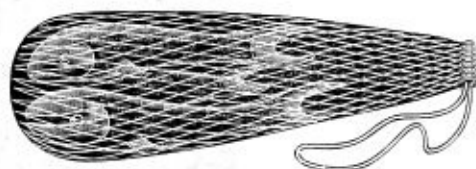

No. ST20FB—Plain bag; with brass rings and draw string at top; length 24 inches; weight per dozen 1¾ lbs. Doz. \$ 4.50

LIVE NETS

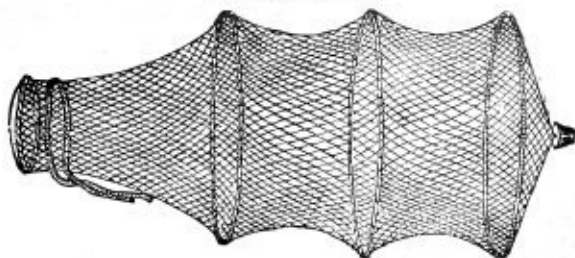

No. ST010—Diameter 10 inches; wire hoops; ¾-inch netting; to tie at top; weight per dozen 8½ lbs. Doz. \$ 5.00
 No. ST012—Diameter 12 inches; otherwise same as No. ST010; weight per dozen 10½ lbs. Doz. 6.00
 No. ST014—Diameter 14 inches; otherwise same as No. ST010; weight per dozen 14 lbs. Doz. 7.00

PLAIN SQUARE DIP NETS

Cotton seine twine; edges fitted with cotton lines; with loop on each corner; 1-inch mesh; No. 12 twine.



No. ST13DN—Size 48x48 inches Doz. \$ 5.70
 No. ST14DN—Size 60x60 inches Doz. 8.40
 No. ST15DN—Size 72x72 inches Doz. 11.40

MINNOW SEINES

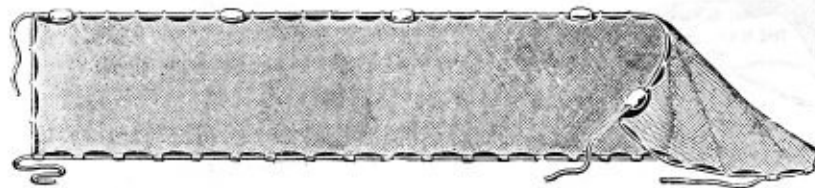

REGULAR

Knit from best quality seine twine; complete with floats and sinkers; depth 4 feet; mesh 1/4-inch.

No. ST342—Length, feet	10	12	15	20
Weight, lbs.	2	2 1/4	3 3/4	3 1/2
Each	\$2.41	2.90	3.62	4.82
	3.74	4.50	5.60	7.50

COMMON SENSE

Heavy woven netting; brown color; complete with floats and sinkers; depth 4 feet; mesh 1/4-inch.

No. ST343—Length, feet	6	8	10	12	15	20
Weight, lbs.	1 1/2	1 1/2	2	2 1/2	3 3/4	4
Each	\$0.90	1.10	1.40	1.60	2.00	2.60

HOOP NETS

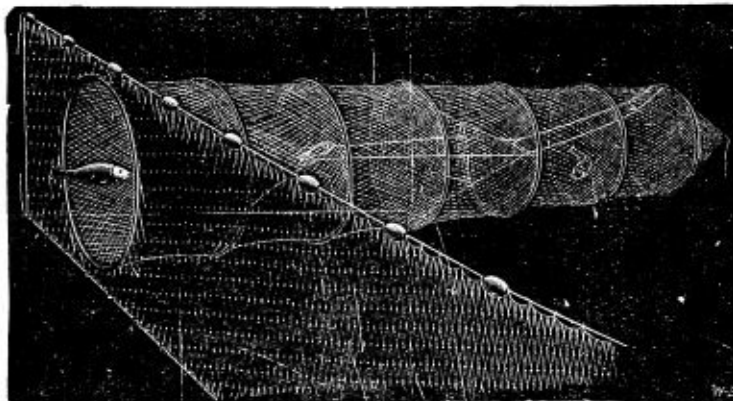

IMPROVED BAIT; WITH WINGS; COMPLETE WITH BAIT BAG

White	*Tarred		Height at Mouth, feet.	Length of Net, feet.	No. of Hoops.	Size, Twine.	Length of Wings on each side feet.	Size of Square Mesh, inches.			Each	
								Front	Middle	Tail	White	*Tarred
No. STB10	*No. STB10T	Double Throat	2 1/2	8	6	16	6	1	1	1	\$ 5.60	*\$ 6.20
No. STB11	*No. STB11T	Single Throat	3	10	6	20	9	1 1/4	1 1/4	1 1/4	6.30	* 7.00
No. STB13	*No. STB13T	Double Throat	4	16	7	24	12	2	1 3/4	1 1/2	9.10	* 10.10
No. STB15	*No. STB15T	Double Throat	5	18	8	28-30	15	2 1/2	2	1 1/2	13.10	* 14.60

FUNNEL BAIT; WITHOUT WINGS; COMPLETE WITH BAIT BAG

White	*Tarred		Height at Mouth, feet.	Length of Net, feet.	No. of Hoops.	Size, Twine.	Size of Square Mesh, inches.			Each	
							Front	Middle	Tail	White	*Tarred
No. STB0	*No. STB0T	Double Throat	2 1/2	8	6	16	1	1	1	\$3.90	*\$ 4.30
No. STB1	*No. STB1T	Single Throat	3	10	6	20	1 1/4	1	1 1/4	4.40	* 4.90
No. STB3	*No. STB3T	Double Throat	4	16	7	24	2	1 3/4	1 1/2	6.80	* 7.60
No. STB5	*No. STB5T	Double Throat	5	18	8	28-32	2 1/2	2	1 1/2	9.60	* 10.70

NOTE—Sizes not listed above can be furnished by shipment direct from factory at market price.

Goods marked thus (*) are for factory shipment only.

TRAMMEL NETS

REGULAR

ALL PRICES ON THIS PAGE ARE MANUFACTURERS' LISTS. WRITE US FOR PRICES.

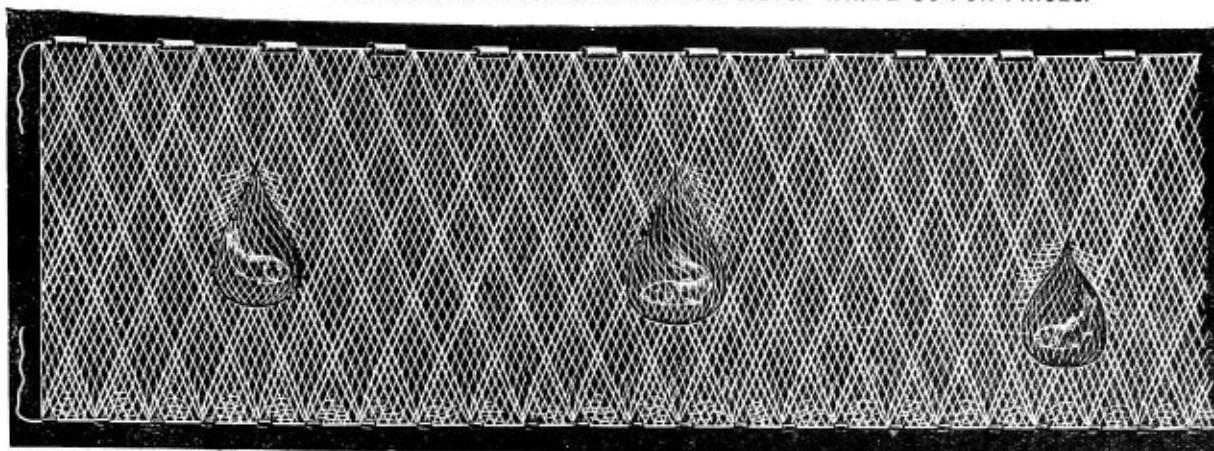

No. ST340—Regular; best quality; No. 16 cotton seine twine outside net; imported linen gilling twine inside net; complete with floats and sinkers.

Length, Yards	Depth, Feet	Outside Mesh, Inches Square	Inside Mesh, Inches Square	Inside Twine	Each
10	4½	7	1¼	25	\$ 2.70
15	4½	7	1¼	25	4.05
25	4½	7	1¼	25	6.75
33⅓	4½	7	1¼	25	9.00
40	4½	7	1¼	25	10.80
15	5	8	1½	25	3.90
25	5	8	1½	25	6.50
30	5	8	1½	25	7.80
33⅓	5	8	1½	25	8.65
40	5	8	1½	25	10.40
50	5	8	1½	25	13.00
*60	5	8	1½	25	15.60
*75	5	8	1½	25	19.50
*100	5	8	1½	25	26.00
*125	6	8	1½	25	36.45
*150	6	8	1½	25	43.65

*BANNER

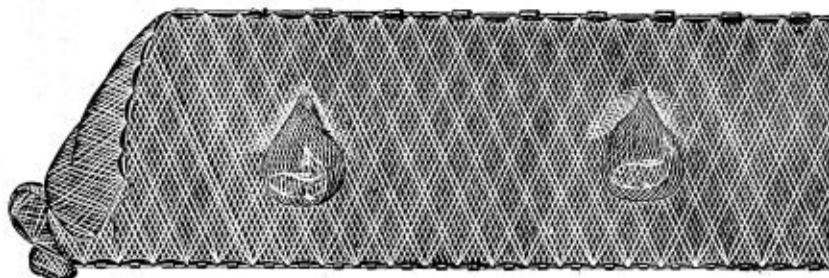

No. ST341.—Banner; extra quality; nets are hung with an extra quality of inside netting of imported linen gilling twine; complete with floats and sinkers.

Length, Yards	Depth, Feet	Outside Mesh, Inches Square	Inside Mesh, Inches Square	Inside Twine	Each
10	4½	7	1¼	25	\$ 3.00
15	4½	7	1¼	25	4.50
25	4½	7	1¼	25	7.50
33⅓	4½	7	1¼	25	10.00
40	4½	7	1¼	25	12.00
15	5	8	1½	25	4.35
25	5	8	1½	25	7.25
30	5	8	1½	25	8.70
33⅓	5	8	1½	25	9.60
40	5	8	1½	25	11.60
50	5	8	1½	25	14.45
60	5	8	1½	25	17.35
75	5	8	1½	25	21.65
100	5	8	1½	25	28.90
125	6	8	1½	25	40.50
150	6	8	1½	25	48.50

NOTE—Any size or style not listed above can be sent from factory at market price.

Goods marked thus (*) are for factory shipment only.

SEINES

LAKE AND RIVER DRAG

ALL PRICES ON THIS PAGE ARE MANUFACTURERS' LISTS. WRITE US FOR PRICES.

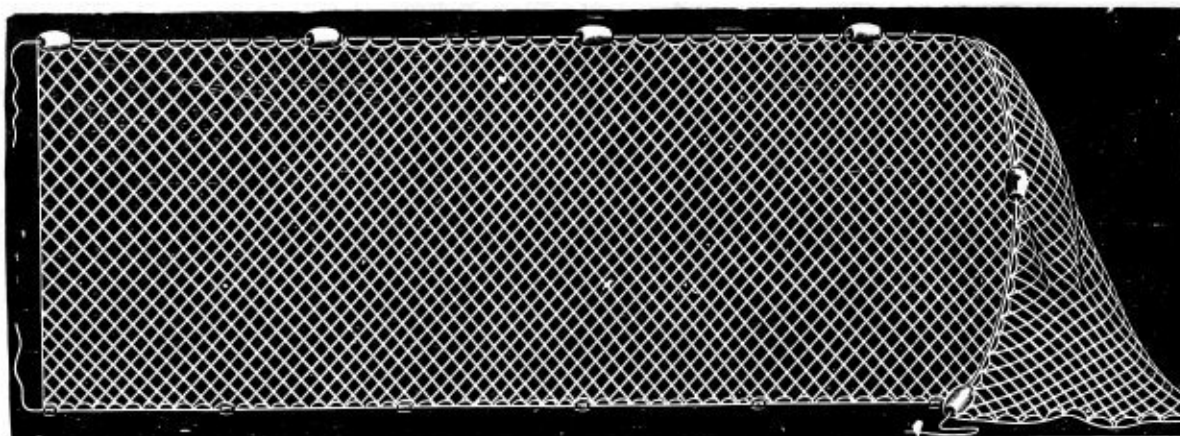

No. ST344—STRAIGHT

Best quality, soft laid, white seine twine; same depth at center as at ends; complete with floats and sinkers.

Length, Feet	Depth, Feet	9-Thread Mesh, Inches, Each		12-Thread Mesh, Inches, Each		
		1	1½	1	1½	1½
20	4	\$1.28	\$1.12
30	5	\$2.56	\$2.20	\$1.92
40	6	3.89	3.37	2.88
50	6	4.86	4.19	3.58

*No. ST344—STRAIGHT

Length, Feet	Depth, Feet	9-Thread Mesh, Inches, Each			12-Thread, Soft Mesh, Inches, Each					16-Thread, Soft Mesh, Inches, Each				
		1	1½	1½	1	1½	1½	1½	2	1	1½	1½	1½	2
20	4	\$1.02	\$1.43	\$1.26	\$1.07	\$0.97	\$0.87	\$1.79	\$1.53	\$1.28	\$1.12	\$1.02
30	5	\$2.15	\$1.89	1.69	1.69	1.52	3.22	2.76	2.27	2.02	1.76
40	6	3.32	2.91	2.56	2.56	2.28	5.01	4.24	3.48	3.07	2.68
50	6	4.14	3.63	3.17	3.17	2.83	6.25	5.32	4.35	3.83	3.34
50	7	4.60	4.04	3.53	5.47	4.70	3.94	3.53	3.12	7.06	5.98	4.91	4.29	3.73
60	8	6.14	5.42	4.70	7.30	6.24	5.21	4.60	4.10	9.51	8.00	6.54	5.73	4.91
75	8	7.67	6.75	5.88	9.12	7.77	6.54	5.76	5.13	11.86	10.00	8.18	7.16	6.14
75	9	8.44	7.46	6.44	9.97	8.59	7.11	6.24	5.57	13.14	10.99	9.00	7.82	6.65

Depth, Feet	Lineal Yard			Lineal Yard					Lineal Yard				
6	\$0.24½	\$0.21½	\$0.19	\$0.29	\$0.25	\$0.21½	\$0.19	\$0.17	\$0.37½	\$0.31½	\$0.26	\$0.23	\$0.20
8	.30½	.27	.23½	.36½	.31	.26	.23	.20½	.47½	.40	.32½	.28½	.24½
10	.37	.32½	.28	.43½	.37½	.30½	.27	.24	.57½	.48	.39½	.34	.29
12	.43	.38½	.32½	.50½	.43½	.35½	.31	.27½	.68	.56	.46	.40	.33½
14	.49	.44	.37½	.58	.49½	.40	.35½	.31	.78	.64½	.52½	.45½	.38½
15	.52	.47	.40	.61½	.52½	.42½	.37½	.33	.83½	.68½	.56	.48½	.41
16	.55	.49½	.42	.65	.55½	.44½	.39½	.35	.88½	.72½	.59½	.51	.43
18	.61½	.55	.46½	.72	.62	.49	.43½	.38½	.98½	.81	.66	.56½	.47½
20	.67½	.61	.51	.79	.68	.53½	.47½	.42	1.09	.89	.72½	.62½	.52

*No. ST345—LAKE AND RIVER, TAPERED

Length, Feet	Depth, Feet		12-Thread, Soft Mesh, Inches, Each					16-Thread, Soft Mesh, Inches, Each				
	Center	Ends	1	1½	1½	1½	2	1	1½	1½	1½	2
20	4	3	\$ 1.34	\$ 1.18	\$ 1.03	\$ 0.93	\$ 0.82	\$ 1.65	\$ 1.44	\$ 1.24	\$ 1.08	\$ 0.93
30	4	3	2.01	1.80	1.54	1.39	1.24	2.47	2.16	1.85	1.63	1.39
40	5	4	3.19	2.78	2.37	2.06	1.80	3.81	3.35	2.88	2.57	2.27
50	5	4	4.00	3.48	2.97	2.57	2.27	4.77	4.18	3.60	3.21	2.83
60	6	5	5.56	4.84	4.12	3.66	3.19	6.69	5.82	4.94	4.38	3.81
72	7	6	7.42	6.44	5.46	4.89	4.33	9.27	7.93	6.59	5.77	4.94
90	8	7	10.61	9.12	7.62	6.75	5.87	12.87	11.07	9.27	8.24	7.21
100	8	7	11.79	10.15	8.50	7.52	6.54	14.32	12.31	10.30	9.17	8.03
120	10	8	16.07	13.80	11.43	10.09	8.96	20.60	17.72	14.52	12.67	10.81

NOTE—Goods marked thus (*) are for factory shipment only.

DUPLEX FOLDABLES

Rigid as metal when open; portable; compact; strong and very durable; made of thoroughly waterproof canvas; metal parts of rust proof spring steel.



FUNNELS

For automobile or auto boats; alcohol, gasoline and naphtha proof; strainer separates water from gasoline and prevents chips, straws, or dirt from passing through; fits the pocket or tool box.

- No. M5½F—Diameter 7½ inches; depth 5½ inches; folds into 7½x3½x1½ inches; weight 1 lb. \$1.50 Each \$ 2.40
Packed, one in box.



WATER PAILS

For anglers, boatmen, campers and horsemen; will not become brittle or decay; without splash guard.

- No. M4WP—6-quart; diameter 10 inches; depth 7½ inches; folds into 11½x5½x2 inches; weight 1¾ lbs. \$1.00 Each \$ 1.50
No. M12WP—10-quart; diameter 11 inches; depth 9½ inches; folds into 13½x6x2½ inches; weight 1¾ lbs. \$1.50 2.25
Packed, one in box.



WATER PAILS

For anglers, boatmen, campers and horsemen; will not become brittle or decay; with splash guard; strainer and spout.

- No. M3WP—6-quart; diameter 10 inches; depth 7½ inches; folds into 11½x5½x2 inches; weight 1¾ lbs. \$1.50 Each \$ 2.25
No. M5WP—10-quart; diameter 11 inches; depth 9½ inches; folds into 13½x6x2½ inches; weight 2 lbs. \$2.00 3.00
Packed, one in box.



MINNOW BUCKETS

For live bait; will keep water cool twice as long as metal; aeration is secured by numerous metal eyelets.

- No. STR6—6-quart; round; diameter 10 inches; depth 7½ inches; folds into 13x5½x2 inches; weight 2 lbs. . . . \$1.50 Each \$ 2.40
No. ST010—10-quart; oval; diameter 12 inches; depth 9½ inches; folds into 15x5½x2½ inches; weight 2¼ lbs. \$2.00 3.20
Packed, one in box.



FISHING CREELS

Aeration is secured by metal eyelets set into front, sides and bottom; shoulder straps securely fastened to metal frame.

- No. ST1FC—Length 10½ inches; width 5 inches; depth 7½ inches; folds into 7x6½x2½ inches; weight 1¾ lbs. \$1.75 Each \$ 2.80
No. ST3FC—Length 11½ inches; width 6 inches; depth 9½ inches; folds into 7½x7½x3 inches; weight 2 lbs. . . . \$2.25 3.60
Packed, one in box.



HANDY BASKETS

For general use; double handles; covers fastened with straps and pull-down hooks; can be used as a refrigerator basket.

- No. M314B—Oblong; length 14 inches; width 8 inches; depth 5¼ inches; folds into 9x7x2 inches; weight 3¼ lbs. \$1.50 Each \$ 2.40
No. M316B—Oblong; length 16 inches; width 9½ inches; depth 7½ inches; folds into 10x8x2½ inches; weight 3½ lbs. \$1.75 2.80
No. M318B—Oblong; length 18 inches; width 11 inches; depth 9½ inches; folds into 12x9x2½ inches; weight 3¼ lbs. \$2.25 3.60
Packed, one in box.

When in Need of Fishing Tackle or Hunting Supplies

REMEMBER

We endeavor to please our customers and at all times carry a complete line of

Fishing Tackle, Guns, Ammunition and Camping Outfits

for use wherever fish and game are to be found.

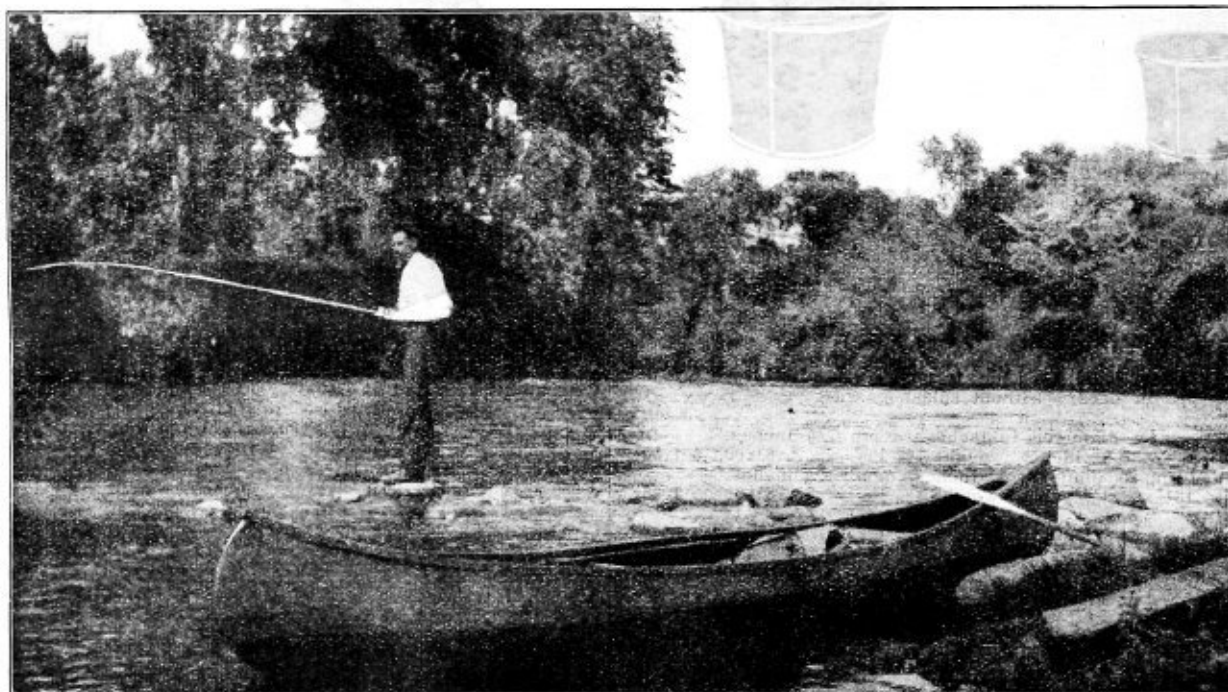

SEND US YOUR MAIL ORDERS FOR QUICK SERVICE

WYETH HARDWARE & MANUFACTURING CO.
SAINT JOSEPH, MISSOURI